

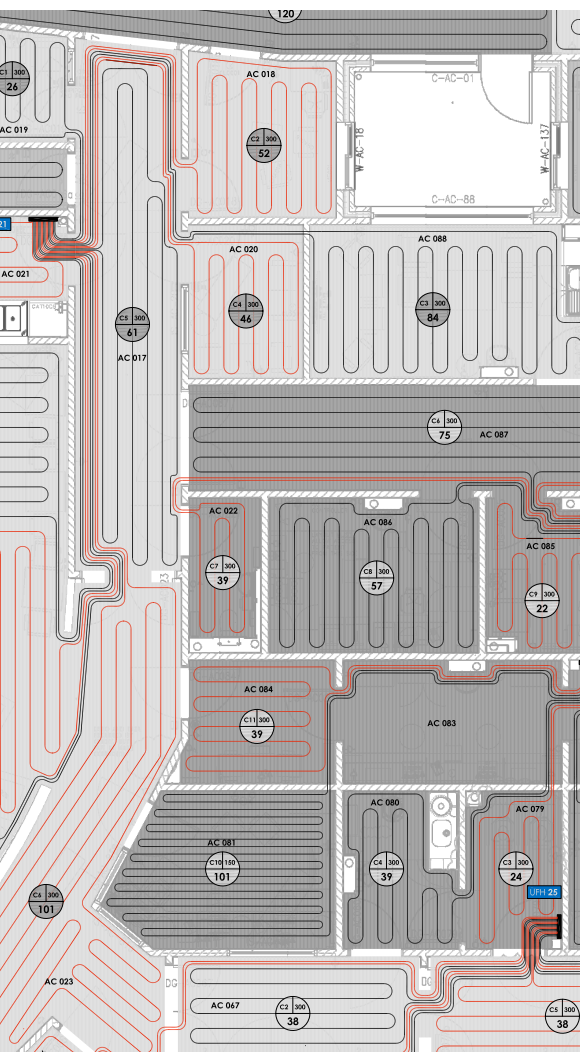

Warmup[®]
The world's **best-selling** floor heating brand™

Global Projects Division

2017



Underfloor heating **feels great.**

Since underfloor heating is invisible it will make the space it is heating **look great.**

It is the **most energy efficient** way to heat a room.

As our **2 million customers** will tell you.

Think Warmup.

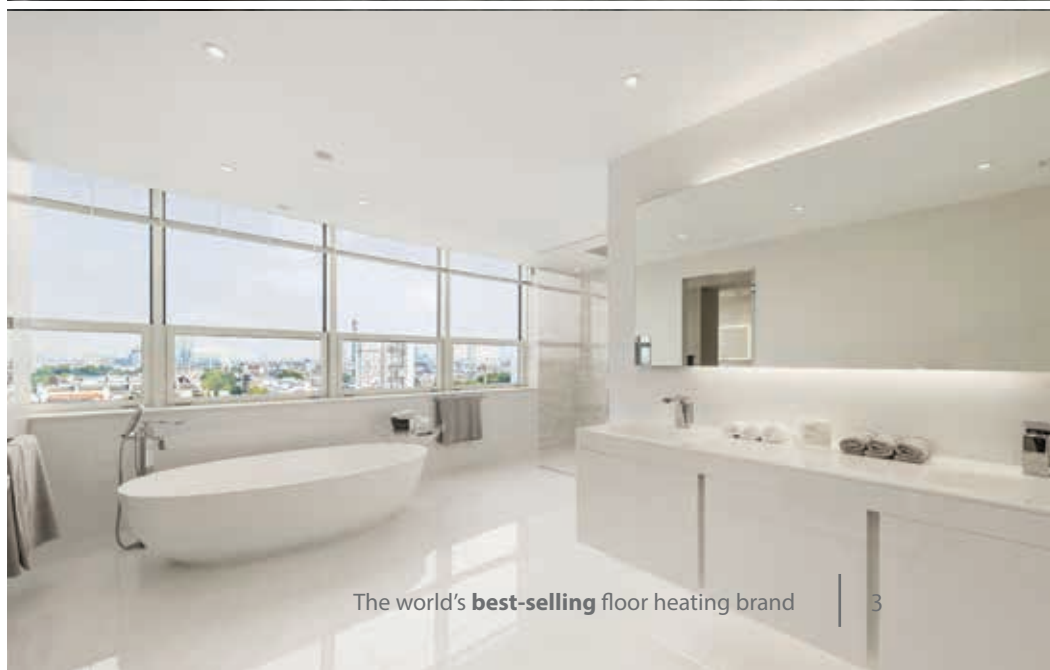

Marathon House

Project type: *Residential*

Project location: *Mayfair, London*

Heating system: *Electric underfloor heating*

Thermostat: *Heating controlled via BMS*

Project size: *305m² – A penthouse apartment*



Warmup 4iE® Smart WiFi Thermostat

For more information see page 34

Right temperature
Best tariff
Effortless



Warmup Research Centre, Bremen, Germany

Laars Krueger, Lead Warmup Research Engineer.

Think

over 20 years of research driven knowledge and experience, – creating innovative new products with Lifetime Warranties.

Think

optimised system
design from experienced
professionals worldwide
– with rapid turnaround.



The Harbour Hospital

Project type: NHS Hospital

Project location: Blackpool

Heating system: Warmup®
Hydronic Clypso™ system

Project size: 11,200m²

Over 40,000m of Warmup®
PEX-A pipe installed from
70 manifolds



Mark Selby's House, 2014 World Snooker Champion

Installation of Warmup® Total-16™ – Low profile hydronic system for rapid heatup time.
For more information see page 44



Think

system installation, expert commissioning and a unique 24/7/365 technical advisory helpline.

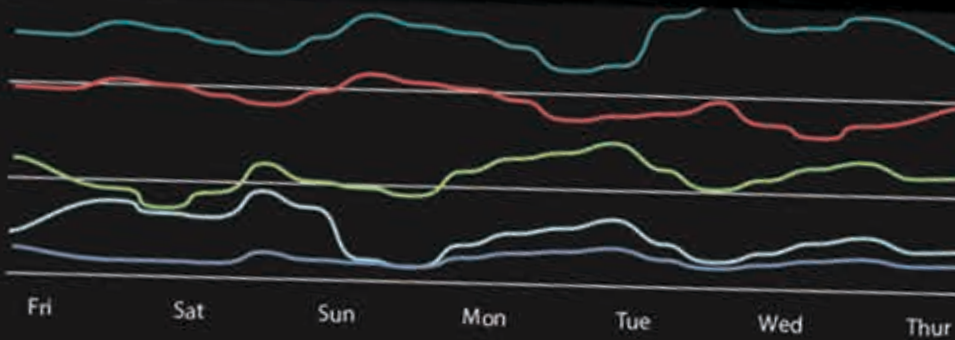

Living Room
Kids Bedroom
Kitchen
Bedroom
Bathroom

DAY

WEEK

MONTH

YEAR

Tips

Turn your heating down 32 minutes early to
save up to £25.64

Think

Warmup designed and manufactured market leading smart connected control devices to achieve:

- ✓ Right temperature
- ✓ Lowest energy usage
- ✓ Lowest energy tariffs

Effortlessly

Even if you want to keep your old radiators!



Intertek



FS 586320



Exceptional Manufacturer of the Year
London Passport to Export Awards



A UK GOVERNMENT CERTIFICATION SERVICE



SOUTH HERTFORDSHIRE • SOUTH BUCKINGHAMSHIRE • NORTH LONDON • NORTH WEST LONDON



CONNECT. INFLUENCE. SUPPORT.

Think

company of substance,
built on research, knowledge
and international experience
gained in over 20 years.

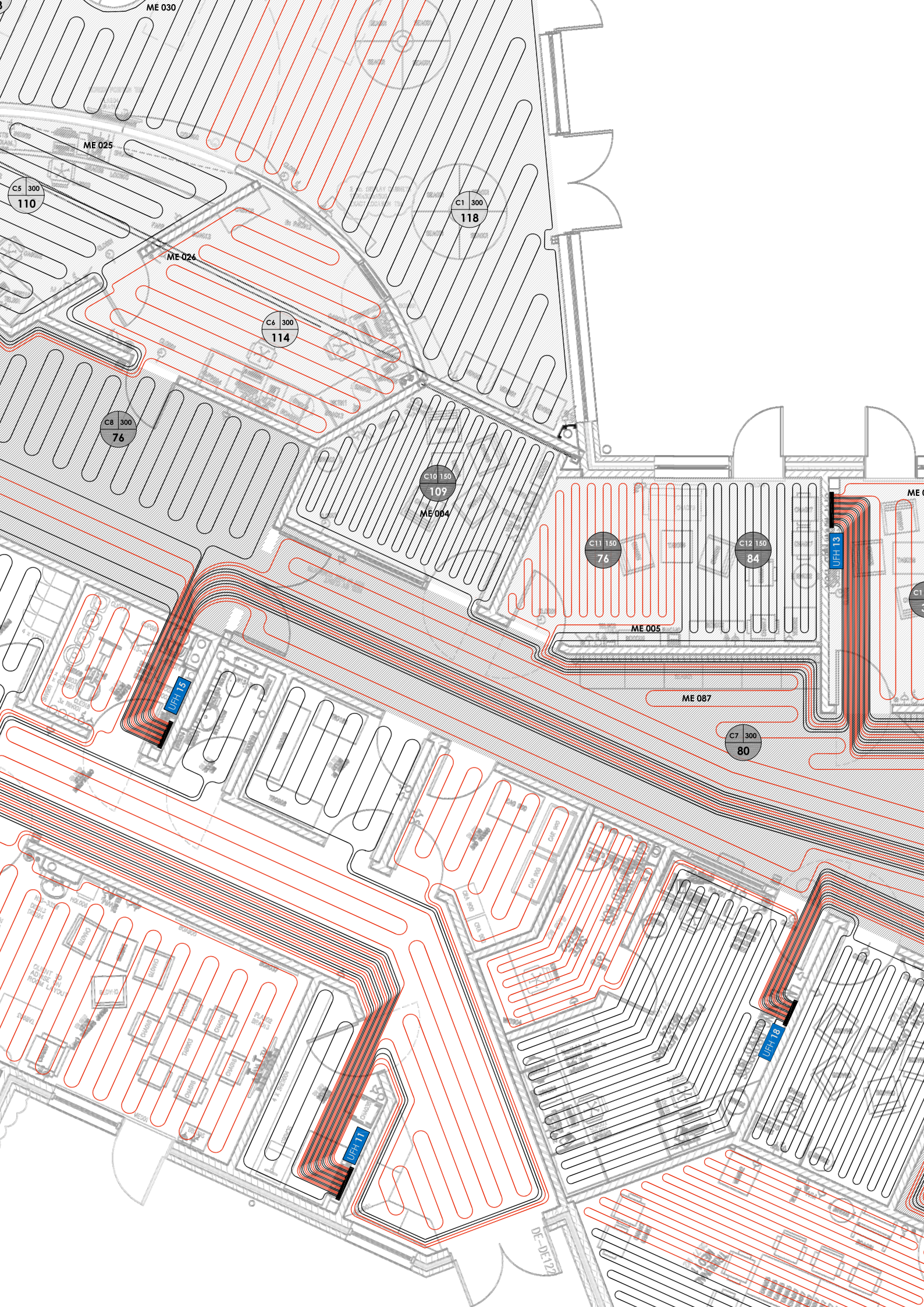

ME 030

ME 025

C5 300
110

C1 300
118

ME 026

C6 300
114

C8 300
76

C10 150
109
ME 004

C11 150
76

C12 150
84

UFH 13

ME 005

ME 087

C7 300
80

UFH 15

UFH 11

UFH 18

DE JEU 12

Contents

Product Selector	P. 16
Welcome	P. 18
Warmup [®] Controls	P. 32
Warmup [®] Hydronic Systems	P. 42
Warmup [®] Electric Systems	P. 64
Warmup [®] Outdoor Heating	P. 78
Warmup Support	P. 84

Warmup System Selection Guide
 Warmup® Electric Systems

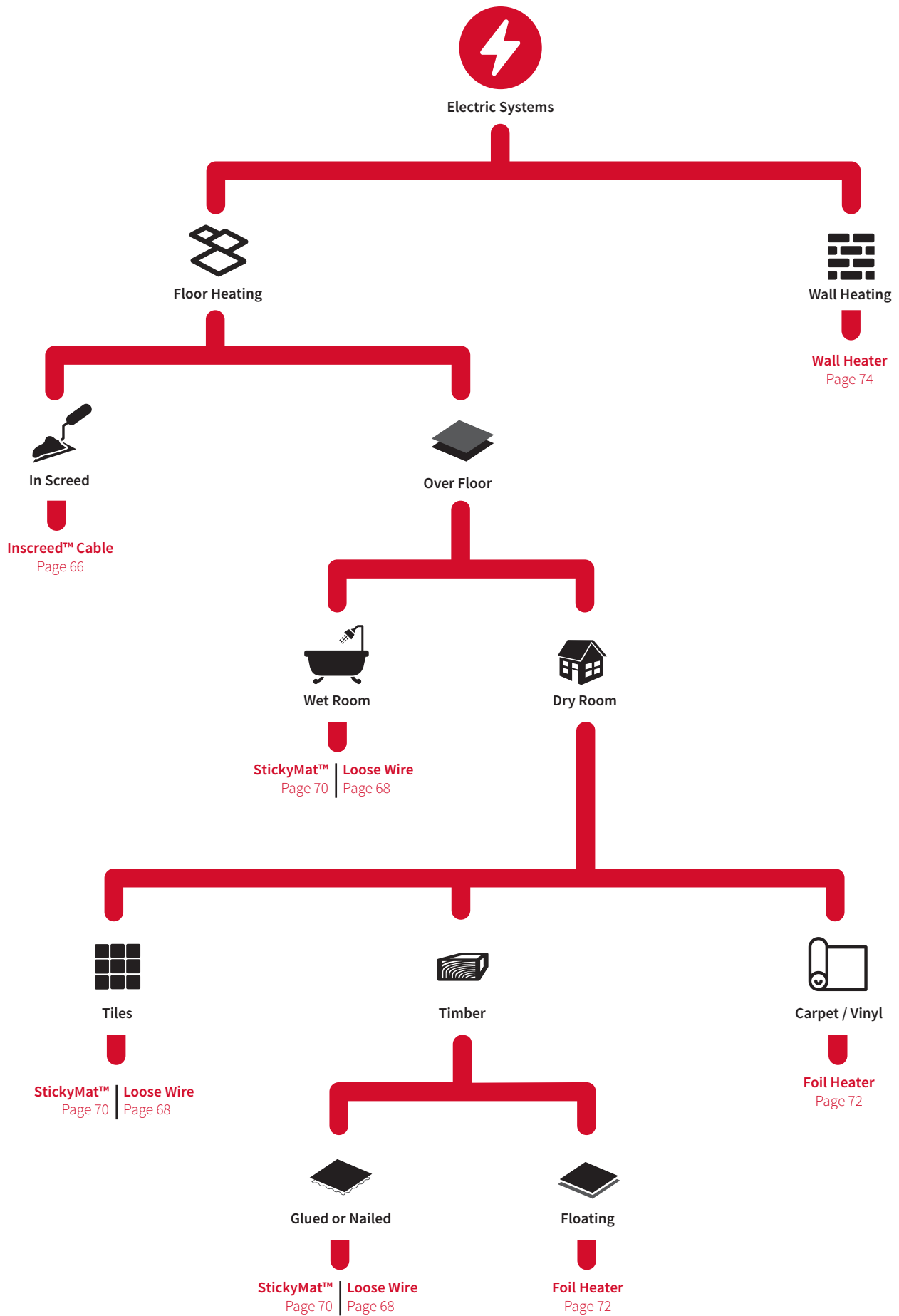

Warmup System Selection Guide

Warmup® Hydronic Systems



Hydronic Systems

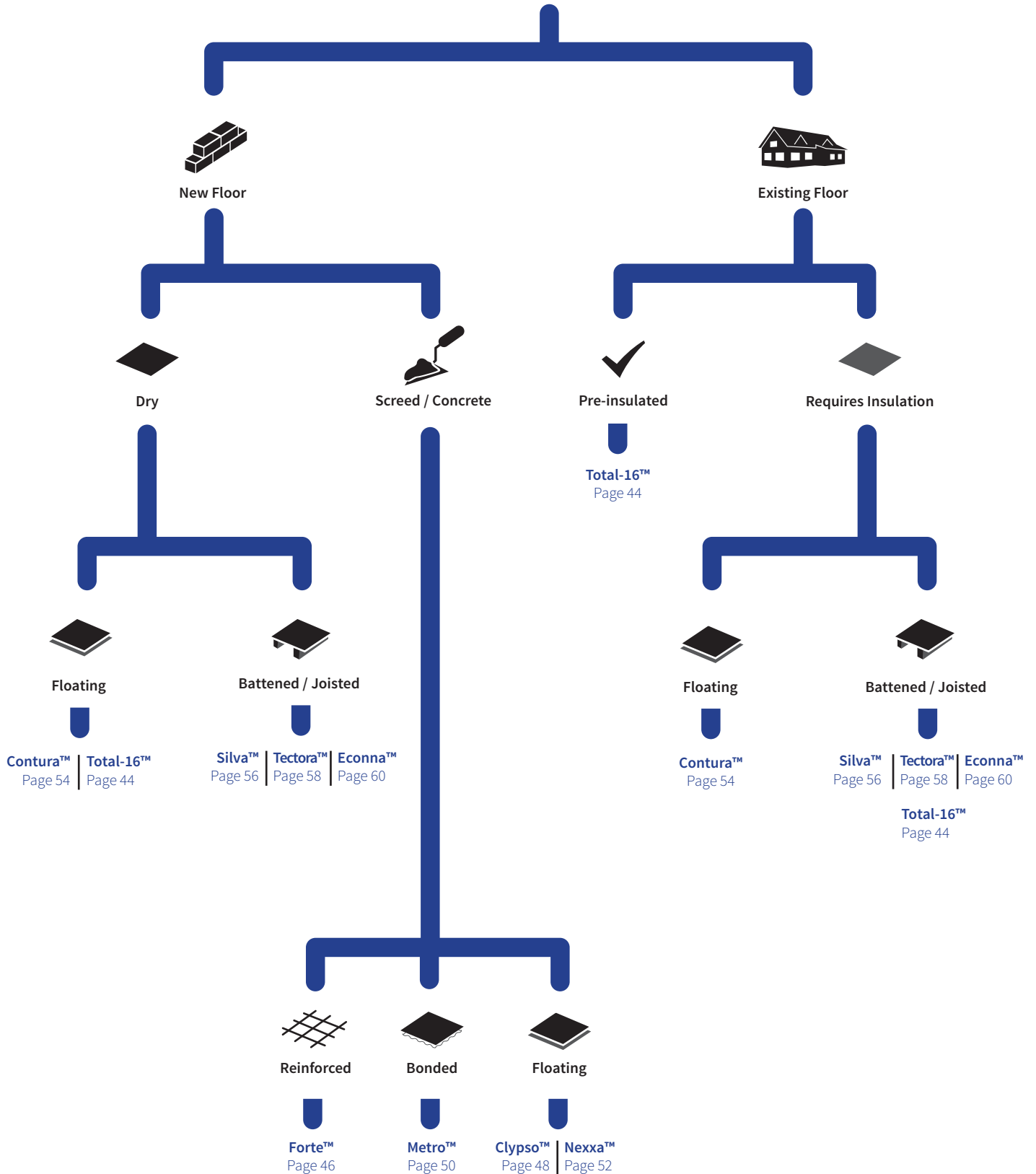

Welcome

We believe that there is no better heating system than radiant floor heating.

The world seems to be moving towards this view. The worldwide industry value in 2014 was estimated at \$4.5 billion and anticipated to grow at 9% compound over the following 5 years.

We manufacture systems, design efficient layouts, install complete projects, commission and offer client support 24 hours per day, seven days per week, 365 days per year in 61 countries around the world.

We have been committed to a research and development lead approach to product and system optimisation for over 20 years. As a result we have a complete range of proprietary integrated systems and controls that are world leading and that have been sold to 2.1 million homes.

Warmup heating systems are currently working in countless homes, hotels, churches, synagogues, mosques, yachts, hospitals, schools, government buildings, football stadiums and of course in the bathroom of Mrs Miggins.

Warmup.co.uk or any one of our other 33 country specific websites around the world contain guides and tools to assist you in your specifications and deliberations.

Research and development by Warmup has created a product design and manufacturing process that allows us to offer lifetime warranties on most of our systems.

This allows homeowners to feel a certain sense of confidence in the system beneath both their feet and their new kitchens or bathrooms. They can call on us to assist them in anyway at any time thanks to that warranty.

Increasingly homeowners are choosing to control their systems from their smart phones, tablets and computers.

Our proprietary range of smart, connected controllers work with our market leading MyHeating™ dedicated portal to deliver what our clients asked us for.

The right temperature

At the lowest cost

Effortlessly

We have achieved this with the most sophisticated yet simple schedule management software, creating maximum energy saving efficiencies and a built in way of assisting home owners to find and switch to the best energy tariffs possible.



Howard Flood, Managing Director
Projects Division, Warmup Plc



EE 4G

11:04 am

84%

Warmup

4IE

22.0°C

Targeting 16.0°C

CHANGE TEMPERATURE



⚡ 2.5 kWh

£0.31

About Our Systems and Services

We will assist you to choose the right systems for the floor structure and finished floor surface.

We will take into account local and national regulations.

The design of the floor heating system can be chosen from the fullest possible range of both hydronic systems and electric floor heating systems.

The best designed homes often combine hydronic and electric systems for optimal, heat up times, energy efficiency and compatibility with the room.

These will be controlled using our proprietary controls.

We will cost the system and its installation within 2 days.

We can provide clear calculations of running costs for the end user and comparisons between different types of systems to allow informed decisions at the right decision stage.

We have a 24/7/365 technical helpline and a national engineering team to assist in all matters. These service levels are unique to Warmup.



Industry Standards

Building Regulations

Part E

Warmup heating systems integrate into all common acoustic floor constructions – screed, suspended timber or dry floating floors – and are being continuously developed to ensure compatibility with all Building Regulations.

Part L

Levels of insulation within a building are of key importance, as the better insulated the house, the more efficient and cost-effective the heating system will be to run. UK Building Regulations have progressively required higher insulation standards and it is easiest to achieve a high standard of insulation during building or major renovation work.

ISO 9001

Warmup has ISO 9001:2008 certification. This certification confirms that Warmup operates and maintains rigorous quality management processes, for the design, development and delivery of underfloor heating products and services to our customers throughout the world. It ensures quality processes are followed within the business, which leads to increased productivity and efficiency in delivering solutions, as well as improving service levels and product quality to customers

The Environment

Warmup is committed to limiting its impact on the environment.

Warmup operates, as far as practicable, in an environmentally sustainable manner and is working towards ISO 14001 environmental management standard conformity.

Warmup already has clear goals, objectives, internal procedures and policies in place. These are used to manage our most significant aspects, e.g. emissions, waste-handling, utilisation of natural resources and energy efficiencies.

All employees are expected to ensure that environmental issues are given adequate consideration whilst conducting their own works, which so far as reasonably practical are to be carried out without risk to the environment.

Research & Development

We believe we provide the best products, best service, best warranties and guarantees and the best information.

This is not a blind belief, it is one we have grown and nurtured through our advanced in-house research and development capability.

Our proprietary products are tested in our own EN442-2 Test Centre, located in Germany, and then validated within various post occupancy monitoring houses in Europe, including the BRE Renewable House.

These houses are fully monitored, allowing us to compile an extremely detailed performance database, which provides us true knowledge of how a Warmup system will operate and the energy it will use.



Why Underfloor Heating?

The purpose of a heating system is simply to provide thermal comfort, but it is much easier to define when we are uncomfortable. We do not really notice when we are comfortable, we do however notice when we are too hot or too cold, when the air is too dry or there is a cold draft and this is where underfloor heating comes in.

There are many different heat emitters available today. The current market leader in terms of sales value is radiators. Radiators have been the default method of installing central heating for many years, so why is underfloor heating consistently taking market share from radiators year after year to become a \$4.5 billion market growing at 9% per year?

Radiators

Ironically, radiators only radiate a small amount of heat with over 70% of it being convected. For double and triple panel radiators it is measurably more than that.

Inevitably the radiator is placed directly beneath a window to combat cold down drafts and because it is the natural “free space on the wall” when it comes to planning the room layout.

It is extremely unfortunate then, that the hottest air in the room, which typically leaves a radiator at 50°C, immediately passes over the weakest thermal element in the whole building. In a typical dwelling a window will lose as much heat through 1m² as a wall will through 8m² and that is assuming that it's closed with the same 20°C air temperature against them both, which obviously is usually not the case.

The hot air then continues up to the ceiling where it pools, losing more heat and moisture to the cooler ceiling before dropping back down to our level.

This is why with radiators we feel hot and stuffy at head height, whilst down at our feet it feels cold and draughty.

Underfloor Heating

Underfloor heating by comparison is largely radiant with very little heat dispersed through convection. This immediately eliminates the excessive heat loss through windows and the ceiling that is attributable to radiators.

For a modern house with specific heat losses in the region of just 30W/m² relative to its floor area, the floor only needs to be heated to around 24°C. For older houses it may be as high as 27-29°C but it is still cool and to the touch will not feel any warmer than our own hands.

Which brings us back to that hard to describe comfortable feeling, whilst standing, our feet will neither feel too hot or too cold.

The air is not overheated, so it does not lose its moisture to the building fabric and we do not feel stuffy. Because we do not feel stuffy, we do not feel the need to open that window above that radiator for all that 50°C air to swiftly flow out of.

With underfloor heating we are not unnecessarily wasting energy and it just feels right!



In addition to the direct benefits over radiators, Warmup Underfloor Heating Systems have many other less obvious benefits that benefit the environment and our wellbeing.

- ✓ With very little convection generated by the underfloor heating system, less dust and other allergens are picked up and circulated within the air
- ✓ The drier floors are inhospitable to dust and carpet mites which normally thrive on the moisture deposited on cold floors by the warm air
- ✓ Walking over an unheated tile or stone finished floor bare foot is no longer something to be “feared”, but something to be relished
- ✓ There is total design freedom with no radiators or other heat emitters taking up floor or wall space, giving you much more usable space to plan with
- ✓ Our advanced thermostats, incorporate decades of knowledge from our in-house research and our post occupancy monitoring scheme
- ✓ The minimal circulation of air allows our thermostats to accurately control the air temperature in each individual room, heating each room only when it is needed, rather than heating the whole house because you would like to be warm when you eat your breakfast in the kitchen each morning
- ✓ Our thermostats and their sensors are placed in the best locations available to give accurate temperature control, rather than being fixed to the side of the heat emitter in the heated air flow whilst trying to regulate the air temperature meters away
- ✓ Underfloor heating is very low maintenance
- ✓ It has been proven that the radiant heat from underfloor heating allows the room air temperature to be 1-2°C cooler for the same level of comfort as radiator systems



Typical Central Heating

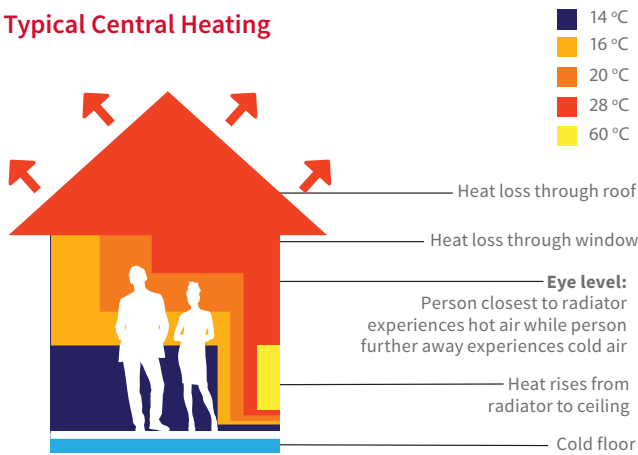

Warmup Radiant Floor Heating

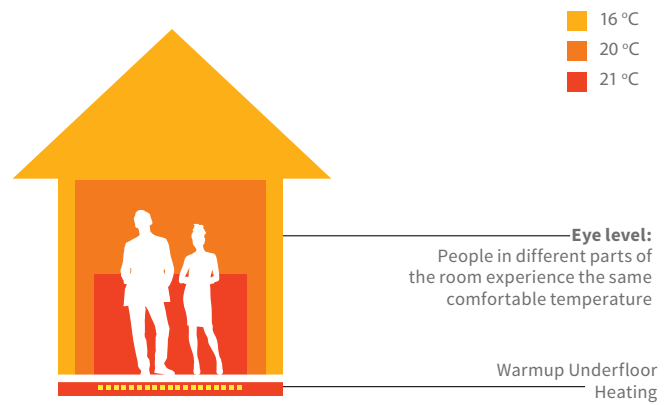

Most importantly underfloor heating is more energy efficient than the alternatives.

We've explained how less heat is lost by eliminating the overheated air that passes over the windows and pools at the ceiling when using radiators. However, that same cycle of air movement for radiators means that while localised patches of the room are brought up to temperature quickly, they are up at ceiling height.

While underfloor on the other hand, gently warms the entire room in unison from the ground up. Getting the occupied portion of the room to a consistently comfortable temperature first.

We've also covered how our underfloor heating is easily tailored to complement your lifestyle using our controls. If we review that early morning routine so many of us go through each day, it would probably be comparable to;

- 07:00 – In Bedroom – Hitting snooze instead of getting up
- 07:15 – In Bathroom – Showering
- 07:30 – In Kitchen – Eating breakfast and possibly preparing lunch
- 07:45 – In Bathroom – Brushing teeth
- 08:00 – Going out the door

It should be immediately obvious that during that time, we are only really using three rooms. Whilst with a Warmup underfloor heating system you would only be heating those three rooms, with less advanced systems you will be heating the entire house, wasting energy unnecessarily. In fact it is likely to account for 20% of the energy used to heat those rooms each year and for no benefit.

For one hour's use in the morning, our research suggests that you would have to pre heat each room with radiators for up to an hour to get the occupied space comfortable. Doubling the time the heating is on from 1 to 2 hours.

There is still a pre heat period with our underfloor heating, but it can be as little as 30 minutes to get the room more comfortable. Consequently, in this scenario the total running time of our underfloor heating is only 1.5 hours, 25% less than the radiator systems. This means the room can stay cooler for longer, so it loses less heat and saves energy.

There is an additional benefit unique to hydronic underfloor heating. Lower water temperatures are required for hydronic underfloor heating to operate as designed, which in turn allows heat sources to operate more efficiently.

At the time of writing, the percentage of condensing boilers installed throughout the UK that actually operate with a return water temperature lower than approximately 54°C, allowing them to condense the flue gasses and recover the heat from them, is unacceptably low.

Conventional systems are typically designed to operate with a flow water temperature of 75°C and a return water temperature of 65°C, so these A-rated condensing boilers are actually operating much more like a B rated non-condensing boiler at 87% efficiency!

With underfloor heating, the return water temperature is likely to be lower than 40°C by design. Allowing the boiler to condense, boosting its efficiency to 94%, an 8% increase relative to the conventional systems.

The benefits with renewable technologies such as air source heat pumps are even more significant.

Current changes to legislation will require that more systems are designed to operate at lower temperatures. While underfloor heating naturally uses low water temperatures, a radiator designed to operate with 40°C return water temperature instead of 65°C will need to be approximately 4 times the size of its predecessor. That will not help the design of the room in question.

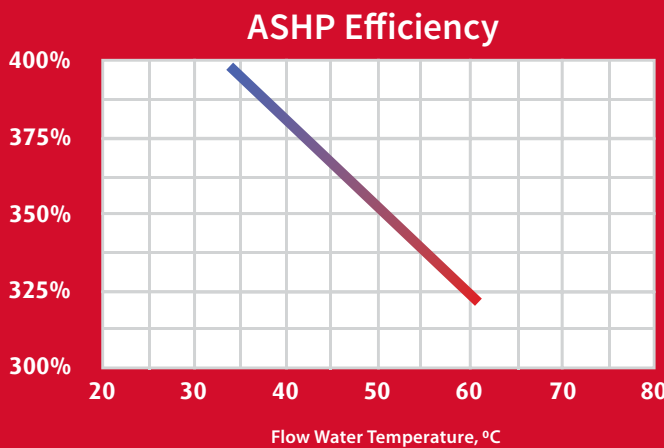
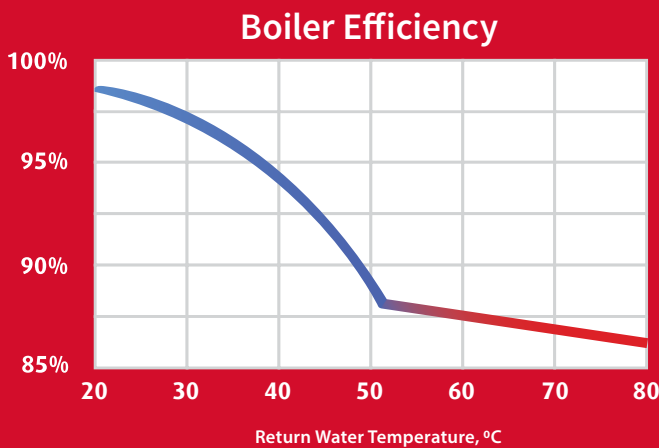

Typical heat source efficiencies by water temperature, Source: BRE – Design of Low Temperature Domestic Heating Systems





The cost of not using Underfloor Heating

It is easy to dismiss underfloor heating on grounds of cost, because there is a common misconception that it is more expensive than gas central heating.

Research & Development Leadership

The combined purchase and installation cost of an electric underfloor heating system is low, comparable to that of a conventional radiator system and that's excluding the cost of the boiler.

While electricity is a more expensive source of energy than natural gas, the Warmup electric underfloor heating systems are exceptionally efficient and maintenance free.

Most central heating care plans start from £10 per month, which is enough to buy an extra 175kWh of energy!

The cost of a care plan, or the one off costs in its absence, combined with the fact that a typical A-rated condensing gas boiler operating at 75°C is just 87% efficient, means that the running costs are also very similar.

While hydronic underfloor heating systems can be more expensive than an equivalent radiator system, they enable boilers to operate at much cooler water temperatures where they will achieve between 91% and 95% efficiency. This reduces the running cost.

When the time comes to redecorate each room, typically one room every three years or so, underfloor heating systems can be left in place and re used.

By comparison radiators suffer wear and tear, and need to be replaced. At the very least they have to be taken off of the wall to ensure that the wall behind them can be finished in line with the rest of the walls.

As time passes, the cost of not using underfloor heating only increases.

Whole Life Cost of Heating

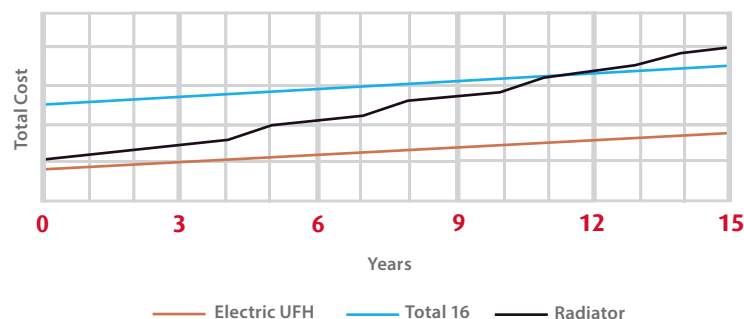

Research and Development

At Warmup we have invested millions of pounds into our research and development programme to invent, innovate and improve upon our products and systems.

In addition we have created a unique product performance database which we use to offer energy and running cost advice for all of our systems. This is unique to the industry.

Research & Development Leadership

By continually investing in research and development, Warmup is able to foresee and respond to upcoming industry trends and technological developments.

This guarantees you fast access to the latest innovations when it comes to underfloor heating design, energy efficiency and reducing CO₂ emissions.

Warmup Research Centre, Bremen, Germany

In order to establish and preserve industry thought leadership, Warmup developed its own EN442-2 Research Centre in Germany. This series of separate test environments together with the dedicated analysis centre is integral to the Warmup business.

This is the main centre for invention, innovation and improvement and coordinates worldwide contribution from all Warmup offices. Results, experience and knowhow is shared with our offices and business partners around the world.

This can range from new wire and pipe types and formats, system control configurations through to materials testing for our partners products. This Research Centre is run jointly with the Product Development Division.



Warmup Research Centre, Bremen, Germany



BRE Renewable House, Watford



Post occupancy monitoring house in Berkshire

Warmup Post Occupancy Monitored Housing Programme

The Warmup post occupancy monitored housing programme grew out of the need to better predict the future energy running costs of houses using Warmup underfloor heating systems.

This information can also be checked and compared with the information provided by the Warmup Research Centre in Germany to create a highly predictive model that allows all manner of key questions to be answered from “How much will it cost to run the heating system of my new, yet to be built house?” to “How much will I save using Warmup radiant underfloor heating rather than radiators in this house?”

Information is gathered every few minutes from many tiny sensors. These are strategically placed in each zone to compare floor, air, wire/water and outside temperatures and often other readings like humidity and radiant temperature. This allows a detailed view of the amount of energy actually needed to create ideal living conditions, we currently collect approximately 1 million datasets each day.

This can be compared with test facility results and in particular, what may have been predicted by the SAP calculations (Standard Assessment Procedure used by the Department of Energy & Climate Change), which are central to the perceived energy performance and efficiency of a dwelling.

SAP, whilst being integral to the construction process of domestic dwellings, by necessity has to be a calculation that can be easily applied across a wide range of circumstances with different input variables and assumptions.

The information and analysis from the Warmup Research Centre and post occupancy monitored housing programme is at your disposal to assist in the design phase for your planners. It can also assist in the marketing/selling phases with prospective buyers.

Warmup underfloor heating is showcased in the BRE Renewable House to deliver low CO₂ emissions, including both embodied carbon and low energy usage. It is proving the perfect system for this CSH Level 4 home which needs very little space heating applied through precise, zoned and accurate controls.

It is also demonstrating how healthier living is achieved by avoiding the creation of cold air currents at floor level and temperature build-up at ceiling level, associated with convection heating air currents.

One of Warmup’s post occupancy monitored houses is situated in Berkshire. It is a 470m² CSH Level 4 house with a 4 person family.

When it comes to running costs, our test studies found that during the winter of 2010-2011 the average running costs (Oct-Feb) were 2.16 pence per sqm per day. Whereas during the winter of 2011-2012 the average running costs were 1.47 pence per sqm per day.

This saving was created by post commissioning adjustments made by Warmup and ongoing technical assistance for optimising performance and energy costs.

Warmup[®] Controls

Warmup Smart Devices are designed, patented and copyright-protected by Warmup

Warmup offers a comprehensive range of controls that we have developed in house, using our detailed knowledge of how hydronic, electric underfloor heating systems and central heating systems operate. More importantly they are designed with knowledge of how people expect them to function.

We understand that the thermostat is normally the only part of an underfloor heating system that is visible, so the modern design of our thermostats can be tailored to make them stand out, emphasising the cutting edge technology that is heating the property, or blended in with the décor.



Warmup

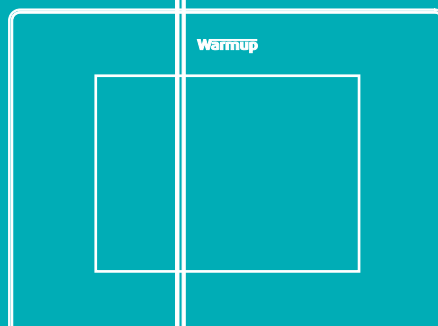

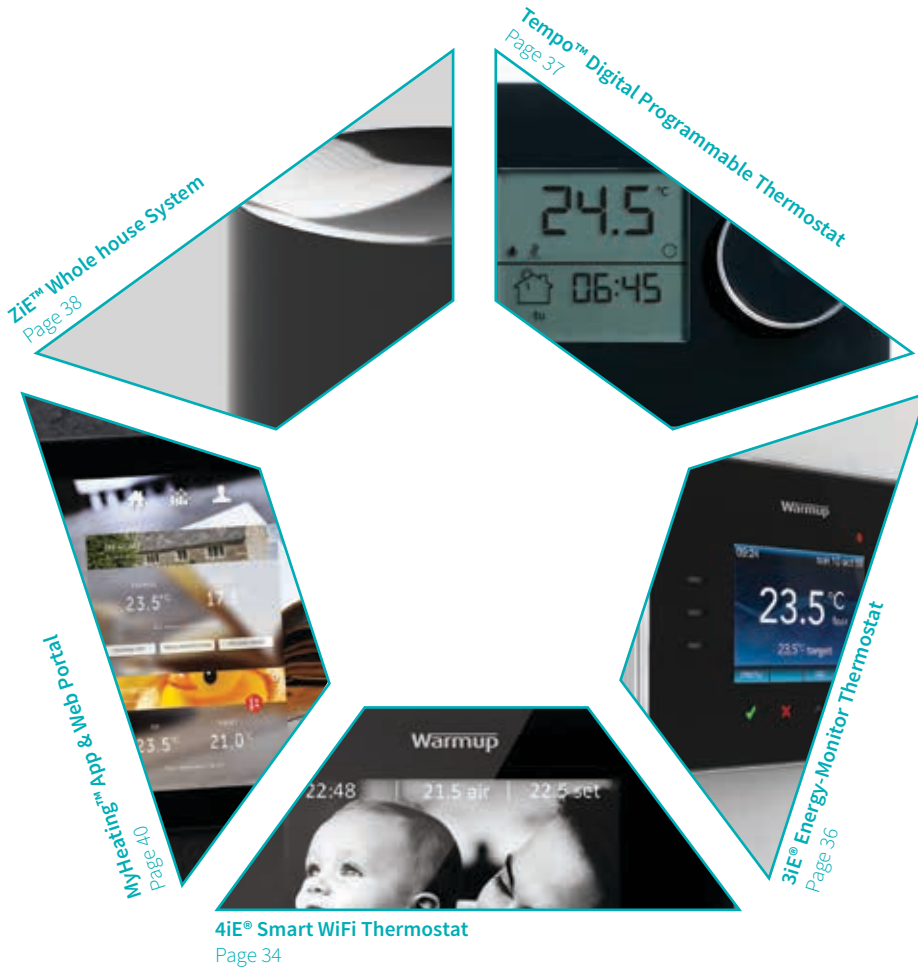

Warmup 4iE[®] Smart WiFi Thermostat

For Central Heating and Underfloor Heating Systems

The 4iE is designed to look great in contemporary and traditionally styled homes.

Connected to the internet by WiFi, it can be controlled from a smartphone, tablet or computer as well as its own touchscreen interface.

It learns how homeowners use their heating and the unique way each zone reacts. It uses this knowledge to suggest ways to save energy, such as

what temperature should be set when the area is not in use and when the heating can be turned off earlier with no noticeable impact on comfort levels.

The 4iE offers many features and benefits that make it stand out from other smart thermostats, offering important advantages to the homeowner and trade professional.





Always at the right temperature, home or away

The 4iE does not require programming. It works with your smartphone to ensure your home is always at the temperature you want, just as you arrive and uses more efficient temperatures when you are away.

If you want to use a conventional program or just want to make a quick change, the MyHeating™ app is simple and easy to use.

The most efficient settings for your home

The 4iE learns how you use your heating and the unique way that your home responds to changes in temperature to calculate more efficient settings.

You will get tips with advice on comfortable temperatures that use less energy and the optimal times to turn the heating off early and still stay warm, **saving up to 25% on your heating usage.**

Automatically on the best energy tariff, year after year

The 4iE can find you lower cost energy tariffs and automatically switch to the best deal. According to the Department of Energy & Climate Change, **switching energy tariff can save on average £210 per year.**

You can choose to let the 4iE switch for you automatically when a better deal is available to see the results and easily switch yourself.

★ Example vinyl Overlays available to personalise your 4iE

Warmup 3iE[®] Energy-Monitor Thermostat

For Underfloor Heating systems

The world's first fully interactive, touch technology, energy-monitor thermostat features an easy-to-use interface, eliminating complicated instruction manuals.

The display shows recorded energy consumption usage, so that users know the exact underfloor heating costs. Up to 10 programmable periods can be set each day to maximise energy efficiency.



Innovative

First thermostat with a 2.4" full colour screen and integrated touch technology – patents pending.

Beautifully crafted fashion colour fascia with chrome edging are perfectly in tune with the modern home environment.

Interactive

Clear graphical display makes any adjustment quick and easy.

Choose the display style that suits you best – wide choice of screen themes.

Intelligent

Proportional Adaptive Function ensures the room does not over-heat, reducing wasted energy whilst also protecting the components inside. The Early Start algorithm learns how long it takes to warm the room and activates the heating so it's up to temperature at the right time.

Installation

The 3iE Energy-Monitor Thermostat should be installed by a certified electrician only, using Warmup's installation instructions.

Energy Efficient

Unrivalled accurate floor temperature control means no wasted energy – reducing the costs associated with over-heating.

Graphical energy monitor shows exactly how much energy is being used and when.

AEM™ prompts you to choose the best and most efficient temperature for each room, maximising energy efficiency.

Warmup® Tempo™ Digital Thermostat

For Underfloor Heating systems

The Tempo™ thermostat enables end users to choose the time as easily as they would with a watch or clock and quickly set their programs – heat on when they want it and off when they do not need it.



Better

Easy-to-use interface and intuitive design.

With Tempo™, end users can simply program their settings to suit individual requirements, warmer when they are at home, lower when they are away or asleep.

Faster

Set-up takes just minutes to get right the first time. It will help avoid wasting energy and achieve savings on utility bills.

Smarter

Its Proportional Adaptive Function ensures the room does not over-heat, reducing wasted energy whilst also protecting the components inside.

The Early Start algorithm learns how long it takes to warm the room and activates the heating so it's up to temperature at the right time.

Warmup® ZiE™ Wholehouse System

Multi-Zone Heating Controls – Coming Soon

The ZiE™ Wholehouse system is the next evolution in intelligent, multi-zone heating control.

The system will fully integrate with the MyHeating™ app and web portal, providing convenient automatic control across multiple rooms, achieving unparalleled comfort and energy control.

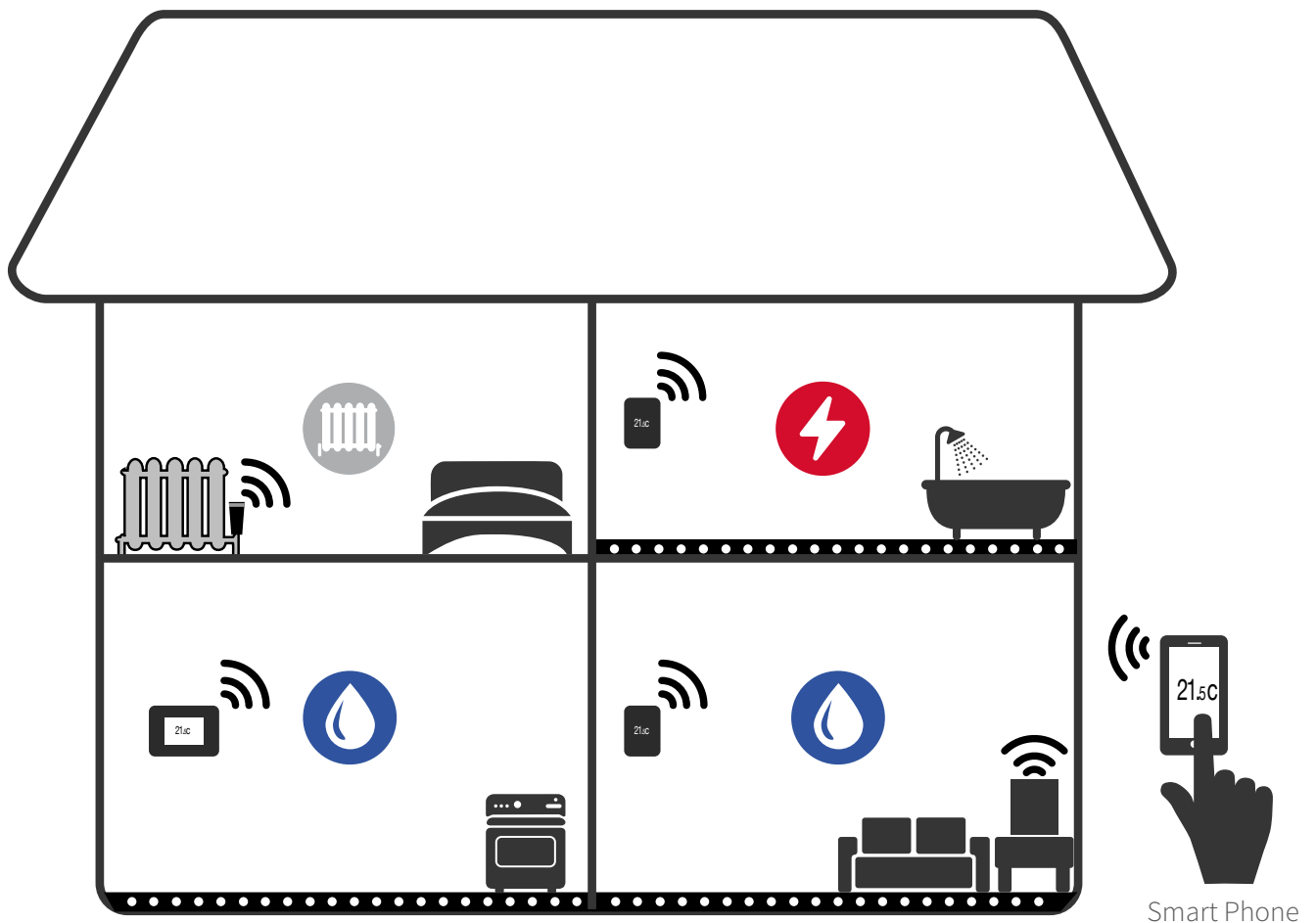

Make your home a Smart Home for less than £1,000

The Wholehouse system works with multiple heating types, including existing radiators, making it easy to set up all your rooms with smart control.

Smart Climate Controllers

Smart Climate Controllers measure temperature and humidity in each room, transmitting wirelessly to the Wholehouse Hub which will act to maximise comfort while minimising energy use with a range of relays and valves.



Smart Radiator Valves

The Smart Radiator Valves work with standard valve bodies, connecting to the Wholehouse system to give precise control of each individual radiator, saving energy and money by avoiding unnecessary heating of empty zones.



Wholehouse Hub

The hub connects wirelessly to each ZiE™ component, coordinating sensors with heaters, ensuring the right systems are on at the right time.



MyHeating™ App & Web Portal

Total control wherever you are, made effortless

The MyHeating™ app and web portal gives you full control of your heating systems using a smart phone, tablet or computer.

Designed for use with the 4iE® and ZiE™ systems, the app and portal deliver fully integrated tools allowing you to understand and improve your comfort while reducing energy usage.

Connected Control, Multiplied

The MyHeating app provides connected control from any internet connected device for multiple users in multiple locations. The powerful system can control multiple heating zones across multiple heating platforms in the same house. No other app provides this level of power and flexibility.

Intuitive

For users who prefer using a set program, MyHeating combines Natural Language Programming and self-learning functions to take the pain out of programming.

MyHeating speaks your language, not tech jargon and learns from regular overrides, adjusting your programme to keep it just right.

Programming a heating system has never been easier.

Intelligent

With features like SmartGeo™, the MyHeating app is designed to run heating systems automatically with virtually no effort on the your part.

MyHeating will also learn your heating usage patterns, how your home reacts and will propose personalised changes to settings to save energy.

Never think about setting the heating again

MyHeating works with smartphones to keep your house at the right temperature automatically. It uses the location services already built in to smartphones to calculate how long it will take you to get home and set the temperature accordingly.

Warmup does not know users' actual locations, only how far away from home they are, and all data is kept secure and encrypted.

Works with all heating zones, all of the time.

MyHeating is great for single heating zones such as central heating and works even better with multi-zone systems like underfloor heating.

By using the automatic settings for different room types, MyHeating can keep zones that are not likely to be used at that time at a comfortable, but more efficient temperature when users are home, ensuring bedrooms aren't unnecessarily heated during the day and just up to comfort temperature when the room is likely to be used.

In fact, it's the only geo-based system that works with zoned heating.



Warmup[®] Hydronic Systems

The Warmup[®] Hydronic Underfloor Heating range has a diverse range of products to suit the varied heating requirements of any project.

We can provide tailored solutions for any combination of new and existing, solid, dry or acoustic floor constructions.

Each system we provide is tailored during the projects design stage to get an optimal balance between the system performance and efficiency

Once complete, the lifetime warranty on our pipe provides true peace of mind that the system will continue to perform.



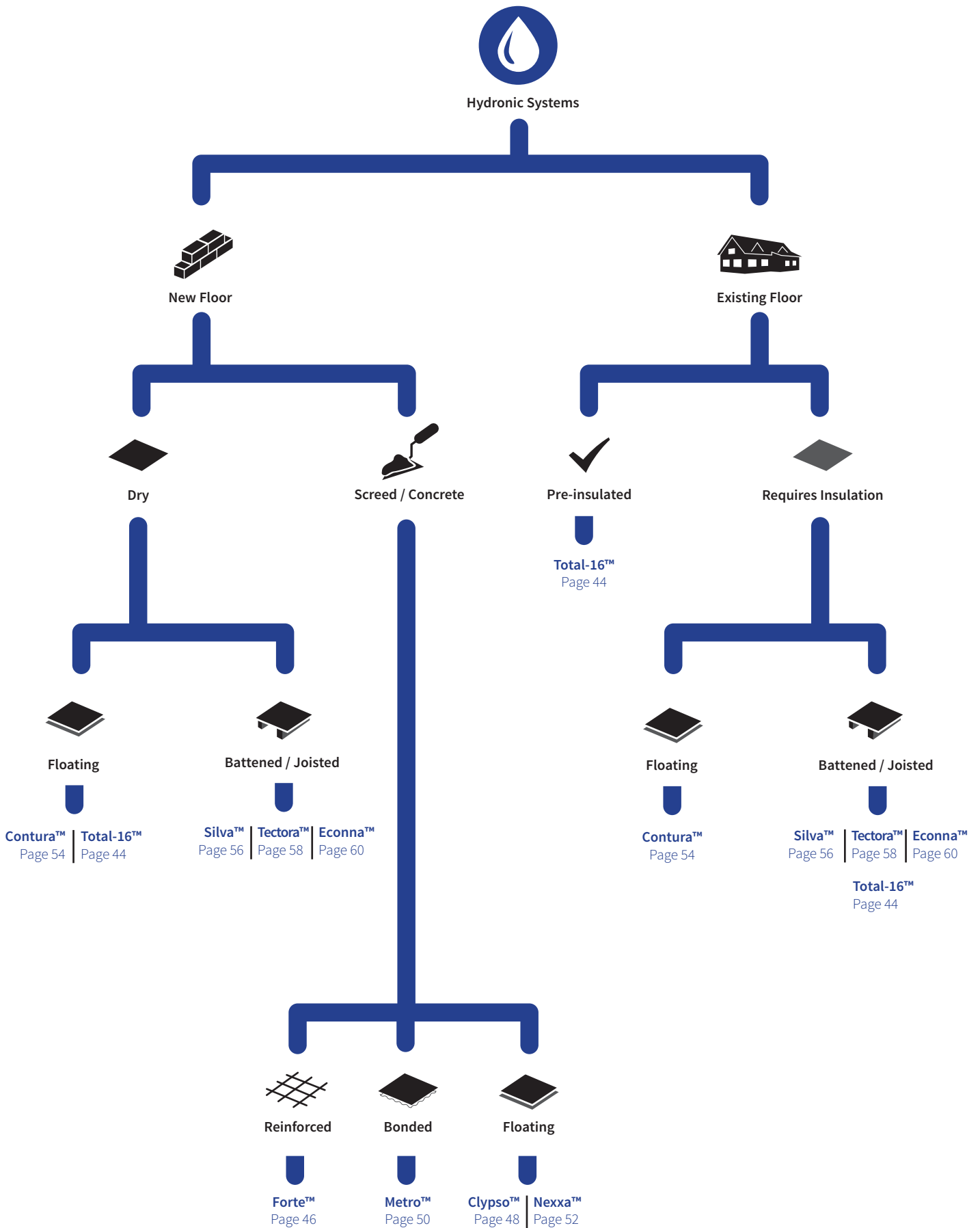

Warmup® Total-16™ System

Low Profile System

The Warmup® Total-16™ Low Profile System is perfect for renovation projects and off-plan installations of Underfloor Heating, adding only 16mm to the floor build up.

Once installed, a full selection of floor finishes can be laid over the system, including tiles which can be bonded directly to the system.

The Total-16 Low Profile System is a robust and easy to handle system of heated Insulation panels, which weigh just 1.7kg each.

The system's high heat output enables higher heat loss properties to be tackled with confidence and modern developments to operate their heat sources more efficiently at lower water temperatures.

This system is perfect for use over either pre-insulated floors, inter-mediate floors or those where it is impractical to lay a thicker system.

If the floor to be heated is none of these, the Warmup® Contura™ System is available in thicknesses up to 100mm and will help to bring the floors insulation level up to those expected of a new build dwelling.

FLOOR CONSTRUCTION

- 1 Ceramic tiles/stone (for residential areas)
- 2 Warmup adhesive
- 3 Warmup primer
- 4 Warmup PEX-A 12mm pipe
- 5 Warmup Total-16 includes:
 - Pre-installed aluminium diffusion plates
 - Insulation (0.034 W/m K @ 10°C)
- 6 Warmup Glue
- 7 Subfloor

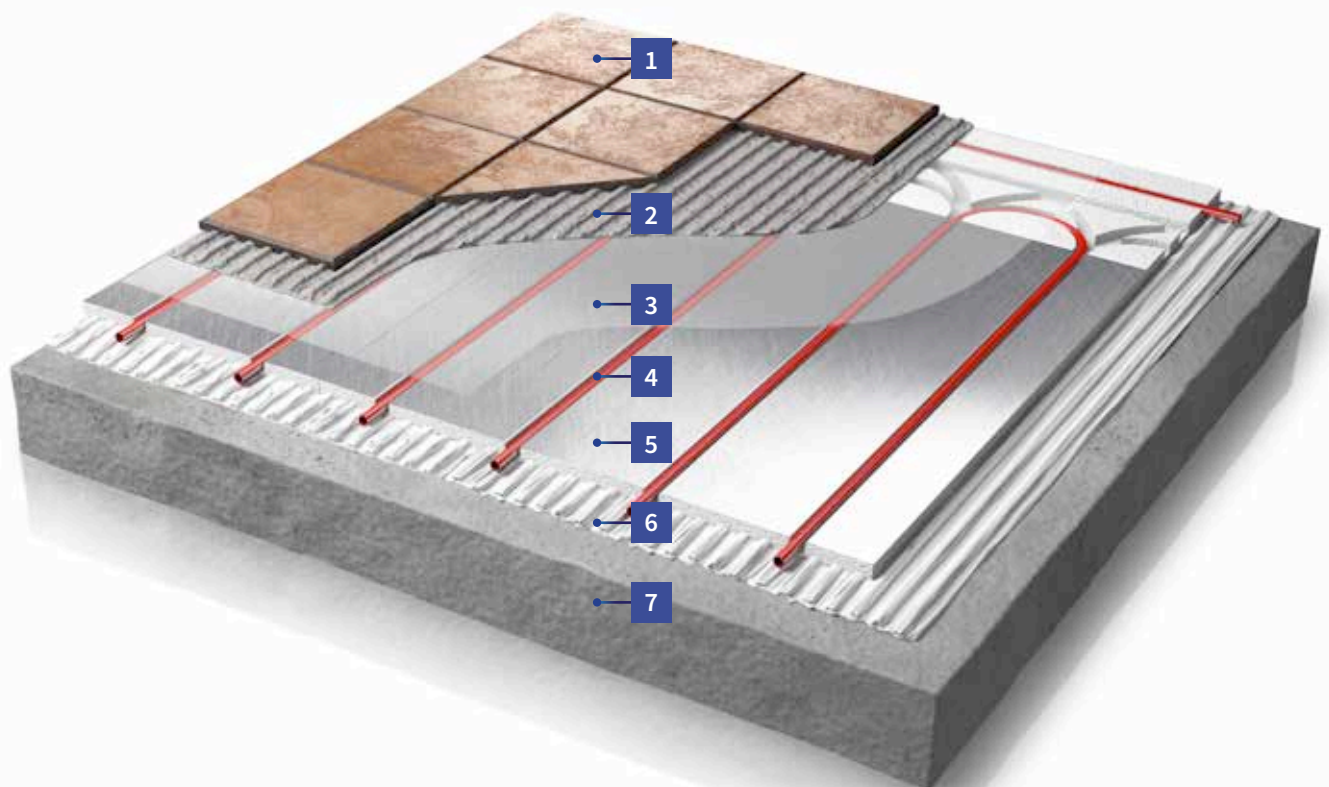

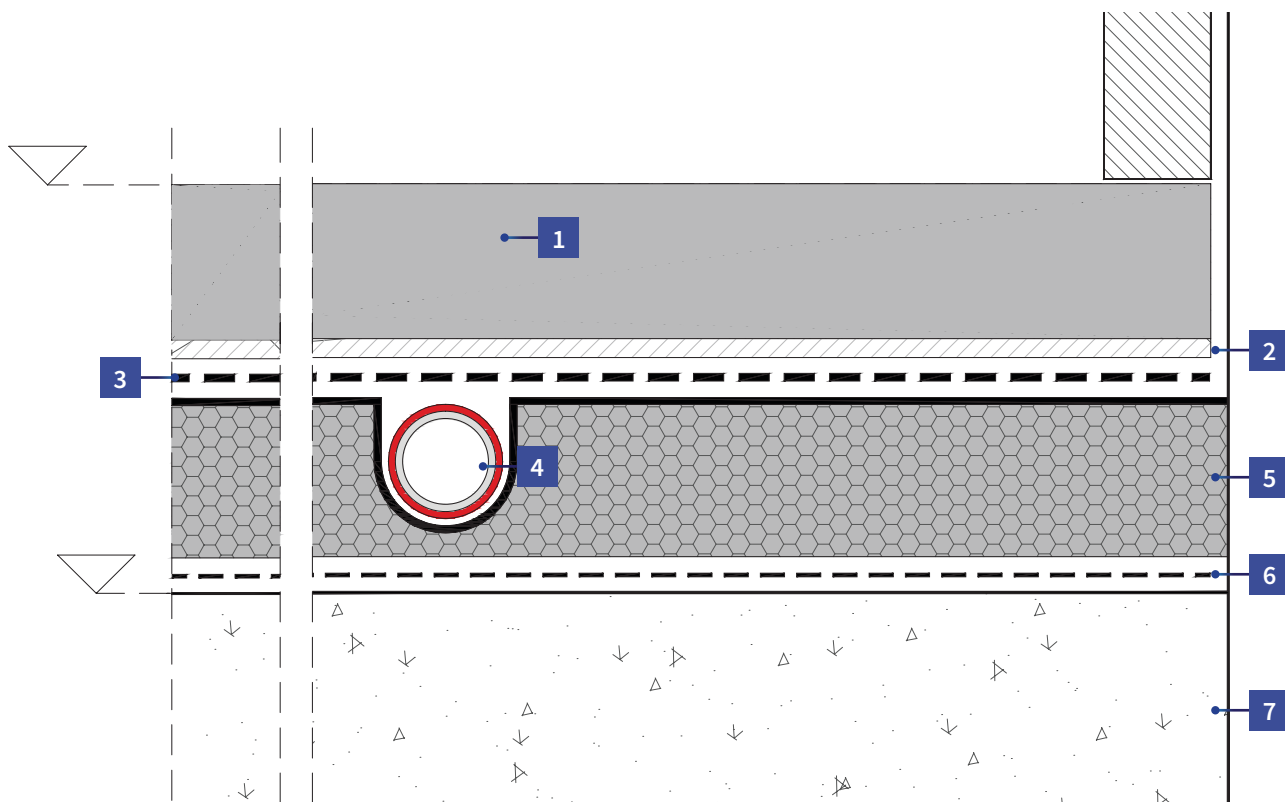

System Description

The Total-16™ Low Profile System comprises of three composite insulation panels; straights, end returns and multi-feed panels.

The end returns are laid at opposing ends of a room and the space between them infilled with the straight heating panels.

The pipe is inserted into the panels before laying the floor finish.

Features

The integrated insulation, while minimal, ensures the systems heating response is rapid with no cold bridging to the sub floor.

In combination with the aluminium diffuser plate, which efficiently warms the heated floor, this minimises the dwellings heat loss by ensuring the pre-heating period of a room is as short as possible.

Technical Information

The systems high compressive strength allows tiles to be laid directly onto it with no requirement for an intermediate supporting layer.

When installed in this way it takes just 35°C water to produce 100W/m² in an 18°C Kitchen.

A 12mm layer of smoothing compound is recommended in wet rooms to create a drainage slope.



CASE STUDY: World Snooker Champion – Mark Selby’s Home

Mark needed a low build hydronic heating system for his house refurbishment project and new-build extension

At just 16mm and tileable, it was the ideal solution. It warms up quickly and efficiently heats Marks house with efficiently generated low temperature hot water.

Combined with the Warmup 4iE® Smart WiFi Thermostat, the Total-16 system keeps Mark’s snooker room at a constant temperature, ensuring the balls run consistently at all times.



View on our website

For complete case studies visit:
www.warmup.co.uk/case-studies/

Warmup® Forte™ System Grid System

The Warmup® Forte™ System is the logical choice for reinforced concrete and screed floors with the pipe tied to the steel reinforcement.

The steel grid enhances the system performance by conducting the heat away from the pipe to create a warmer and more even surface temperature.

The Forte System is quick and simple to install, with the pipe simply zip tied to the reinforcement being used.

Once in place, the pipe is resilient to disruption on site and suitable to receive a power floated concrete floor.

Reinforced concrete floors typically have a higher thermal mass than thinner, lighter floating screed floors. This will extend the time the system

takes to warm up and cool down, generally making the system better suited to continuous operation.

For intermittently heated spaces, it is worth considering laying a floating screed or dry floor construction.

FLOOR CONSTRUCTION

- 1 Floor finish
- 2 Concrete
- 3 Warmup 16mm pipe
- 4 Steel reinforcement
- Supported at mid depth of concrete
- 5 Damp Proof Membrane (DPM)
- 6 Warmup® Metro™ Insulation
- 7 Damp Proof Membrane (DPM)
- 8 Subfloor

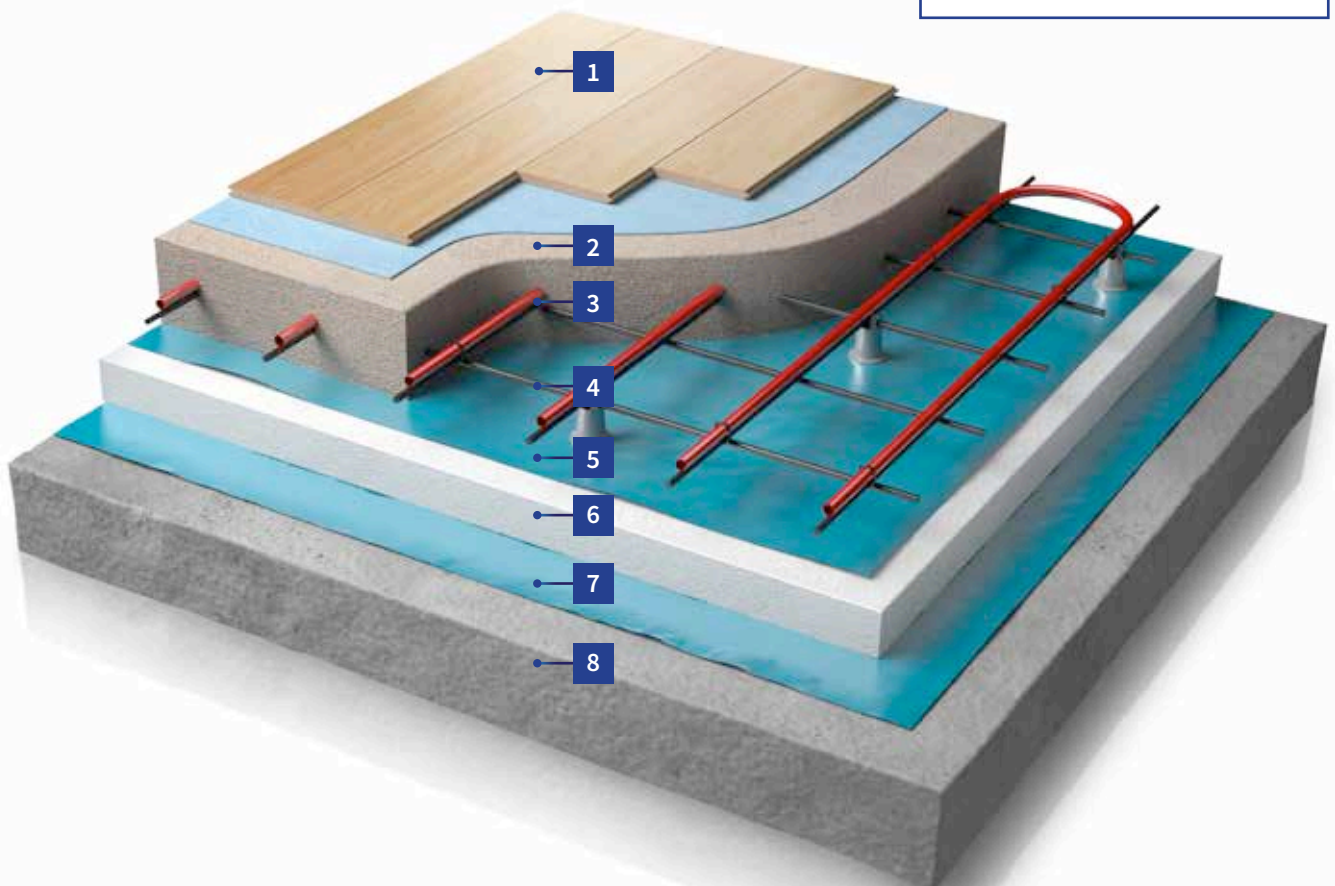

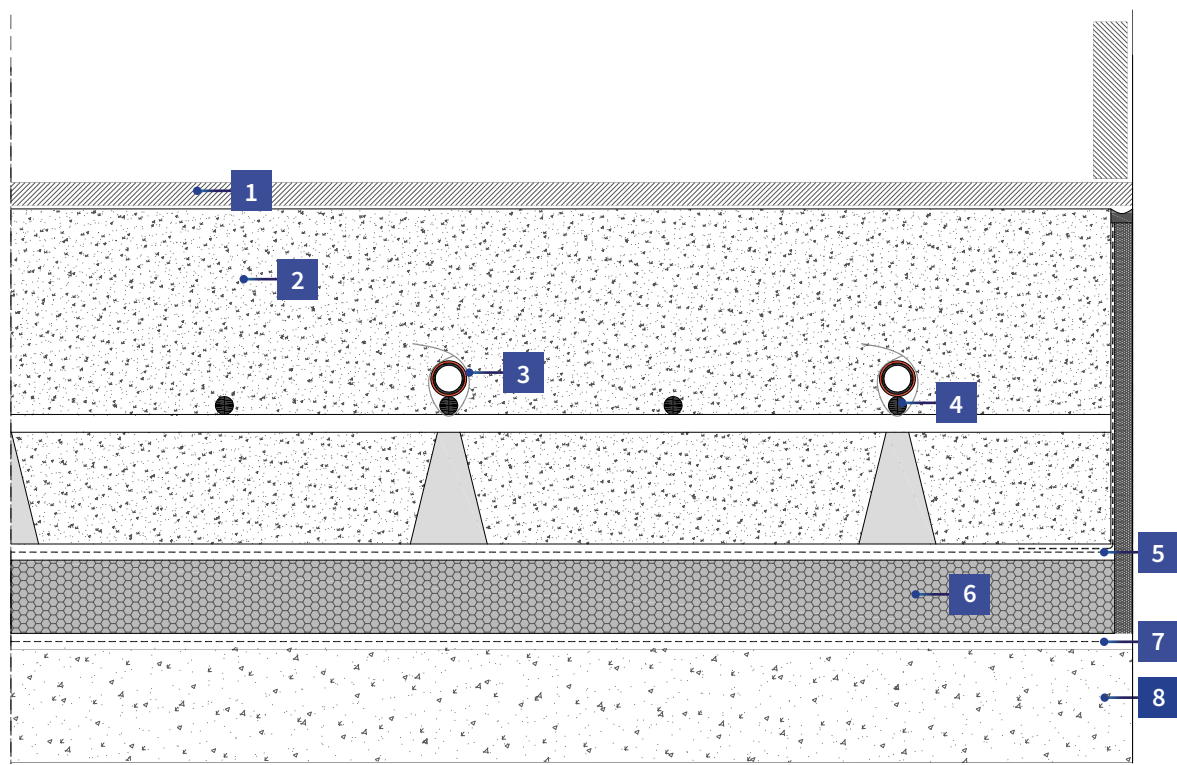

System Description

The insulation layer, DPM and steel reinforcement should all be installed before beginning the Forte™ Systems installation.

Once the reinforcement is set at the correct height, the pipe is fixed in place using zip ties.

The screed or concrete is then laid over the installation after completing a pressure test.

Features

When casting a structural concrete floor, before erecting any walls, the flow and return pipes can take very efficient routes back to the manifold.

This reduces the installation time associated with carefully routing the flow and return pipes through doorways and around the perimeters of existing rooms.

Technical Information

With the pipe located at mid-depth within the floor, it is located closer to the floor surface than with other systems of the same depth.

This factor, combined with heat diffusion of the steel reinforcement, means the Forte System typically emits 5-10% more heat than a system without reinforcement, operating at the same water temperature.



CASE STUDY: Apartments, Manchester, UK

This new build development was being constructed with cast-in-situ reinforced concrete floors. Warmups expertise was called upon to design and supply a bespoke systems using its PEX-A pipe.

To achieve a rapid and accurate installation, the Forte system also integrated the Metro rail, which was fixed to the steel reinforcement before the pipe was clipped into place at 150mm centres. Once tested, the concrete was poured and the structure completed.



View on our website

For complete case studies visit:
www.warmup.co.uk/case-studies/

Warmup® Clypso™ System Staple System

The Warmup® Clypso™ System is designed for use within floating screeded floors. Typically, it does not affect the depth of a floors construction.

The cost effective Clypso Clip allows for flexible installation of the pipework prior to laying either a standard, or a proprietary screed.

The Clypso System's simple free form nature allows for great flexibility in system design and installation, with curved and irregularly shaped rooms being no harder to fit out than a regular one.

A pair of competent installers working together can fix the pipe quickly and precisely, whilst easily accommodating unforeseen site details.

If there is likely to be heavy third party traffic through the site during the systems installation, that could disrupt the pipe before the screed's laid, then the Warmup® Nexxa™ Panel System is recommended.

The Nexxa Panel provides better shielding to the pipe, reducing the risk of it being damaged or dislodged before the installation is completed.

FLOOR CONSTRUCTION

- 1 Floor finish
- 2 Screed
 - 65-75mm Sand and Cement Screed, or
 - 35-45mm Proprietary screed
- 3 Warmup 16mm pipe
- 4 Warmup Clypso Clip
- 5 Warmup Clypso Insulation
- 6 Damp Proof Membrane (DPM)
- 7 Subfloor

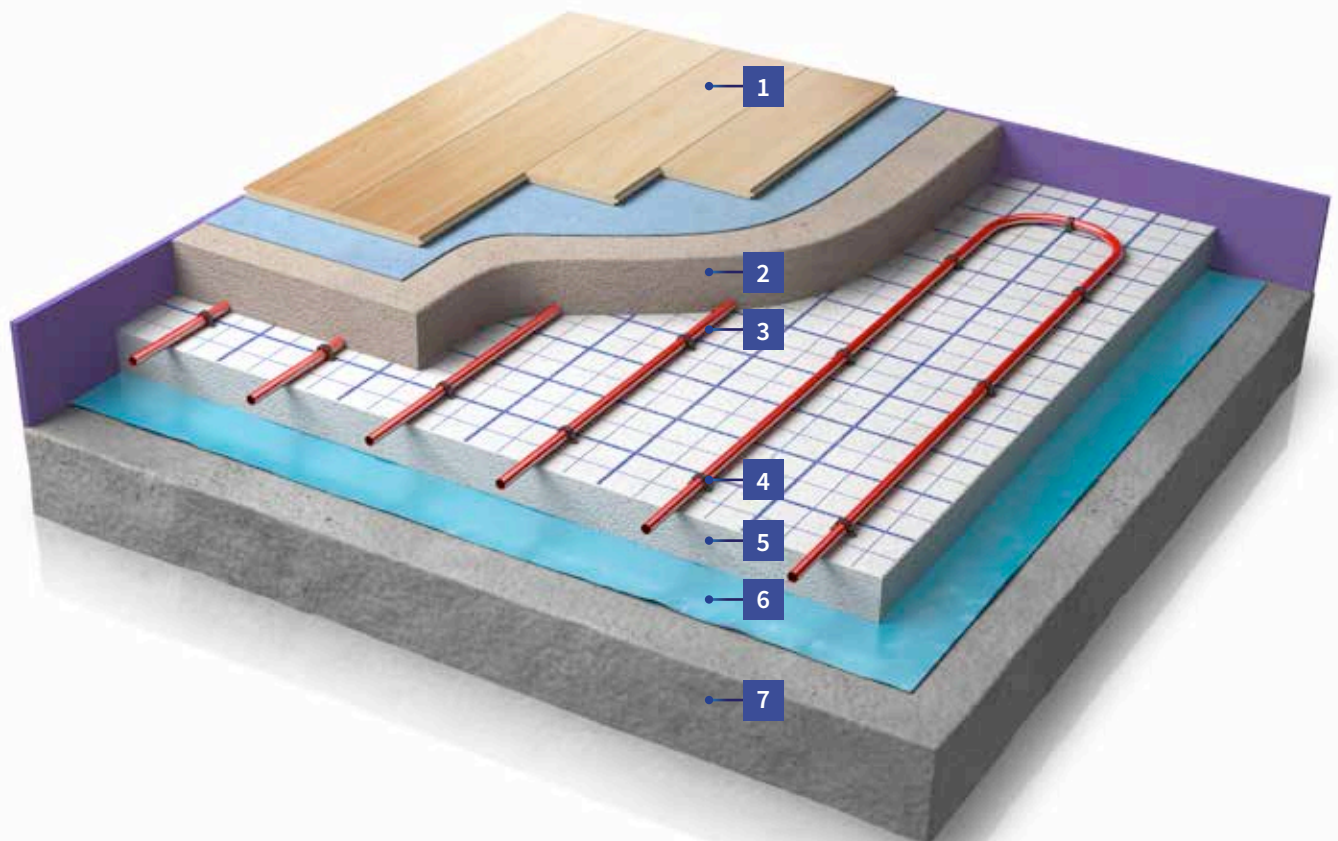

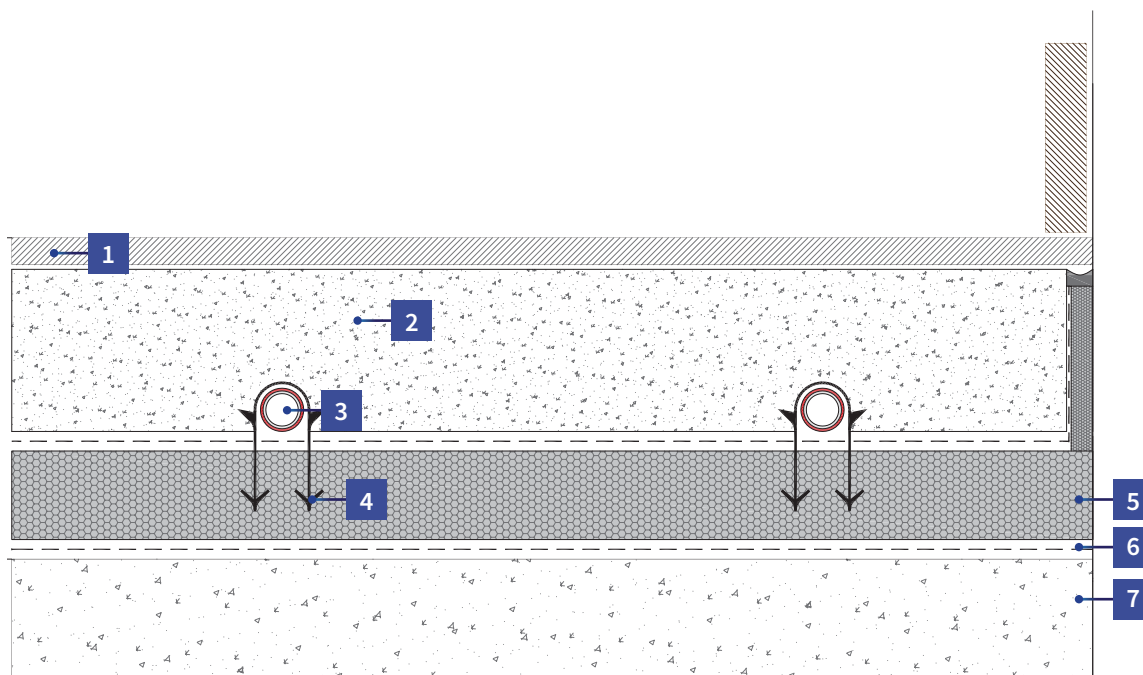

System Description

The Clypso™ System uses Clypso Clips to fix the pipework to a rigid layer of insulation.

The Clypso Clips are fixed from a standing position using the Clypper Tool, or an equivalent third party product.

A layer of screed is then laid over the pipes and insulation to complete the floating screeded floor.

Features

Warmup also offers Clypso Insulation Panels as part of this systems package.

The 50mm x 50mm grid, marked on the reinforced PE top surface, aids installers in accurately fixing pipes in position, whilst also providing a more robust fixing surface for the Clypso Clips.

Technical Information

The Clypso Insulation Panels are available in a range of thicknesses from 25mm to 100mm, with a thermal conductivity of 0.022W/mk.

The Clypso Clips are available in two lengths, 40mm and 60mm. The 60mm version offers superior fixing strength while the 40mm one only requires a 25mm layer of insulation, making them well suited to intermediate floors.



CASE STUDY: The Harbour Hospital, Blackpool

This brand new 11,000m² hospital development on the Fylde coast is heated by the Warmup Clypso System utilising the Warmup PEX-A pipe.

The pipes lifetime warranty provided the confidence that was needed to proceed.

Various floor finishes were used throughout the hospital. Working with the design consultants, we developed an innovative way to insulate the distribution pipework within the screed, giving greater control and removing the risk of aging sensitive floor finishes.



View on our website

For complete case studies visit:
www.warmup.co.uk/case-studies/

Warmup® Metro™ System Rail System

The Warmup® Metro™ System is designed for use within either a floating or a bonded screed floor.

The Metro Rail allows for quick, consistently spaced, installation of the pipework prior to laying either a standard, or a proprietary screed.

The Metro rails have integral clips, spaced at 50mm intervals, which provide a level of installation precision which is difficult to achieve with the Clypsos™ System.

They offer a robust fixing mechanism that is resistant to disruption from site traffic, ensuring that the finished system matches the design and performs as it should.

For bonded screed floors they are simply laid over the primed, pre insulated sub floor, before applying the screed.

Within irregularly shaped rooms, where frequent changes in pipe direction are required, the Nexxa™ Panel offers more flexibility in pipe fixing patterns.

FLOOR CONSTRUCTION

- 1 Floor finish
- 2 Screed
 - 65-75mm Sand and Cement Screed, or
 - 35-45mm Proprietary screed
- 3 Warmup 16mm pipe
- 4 Damp Proof Membrane (DPM)
- 5 Warmup Metro Rail
- 6 Warmup Metro Insulation
- 7 Damp Proof Membrane (DPM)
- 8 Subfloor

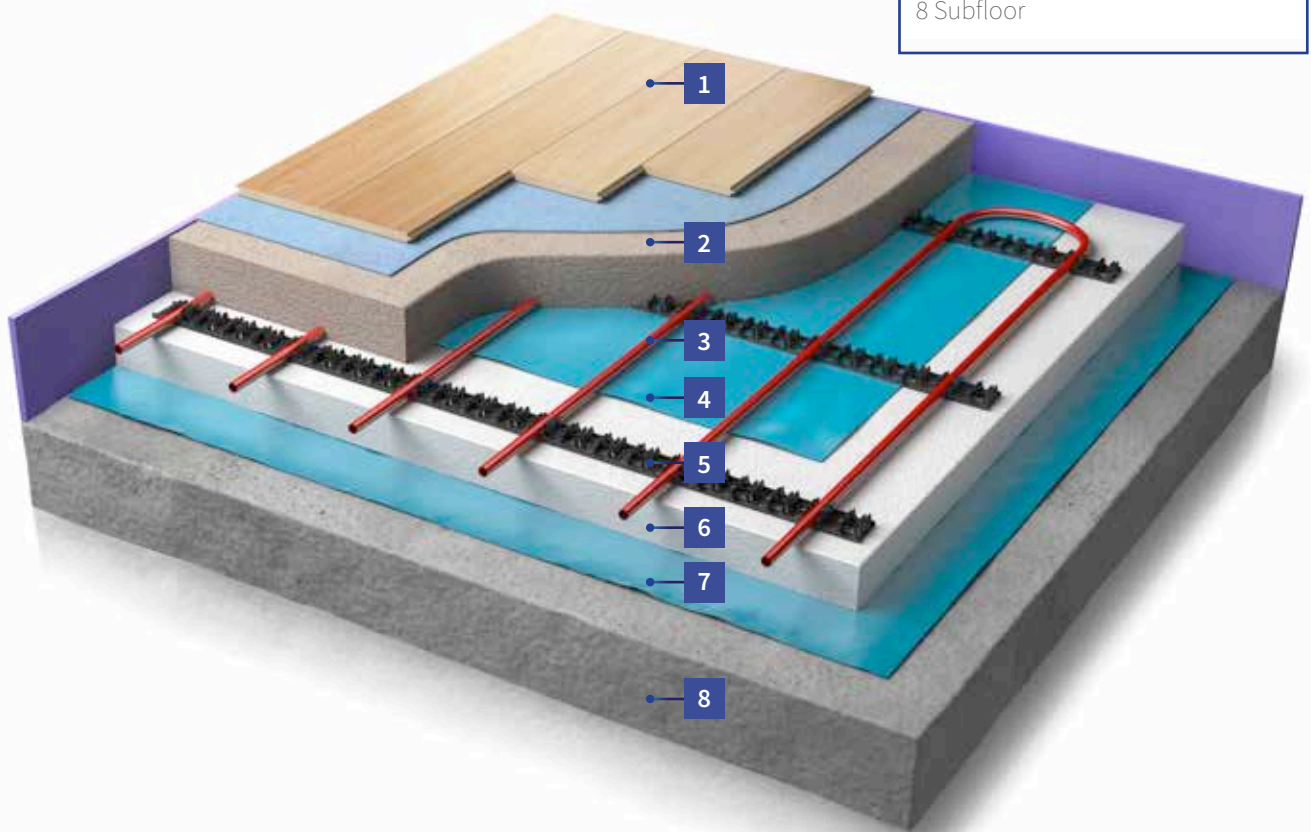

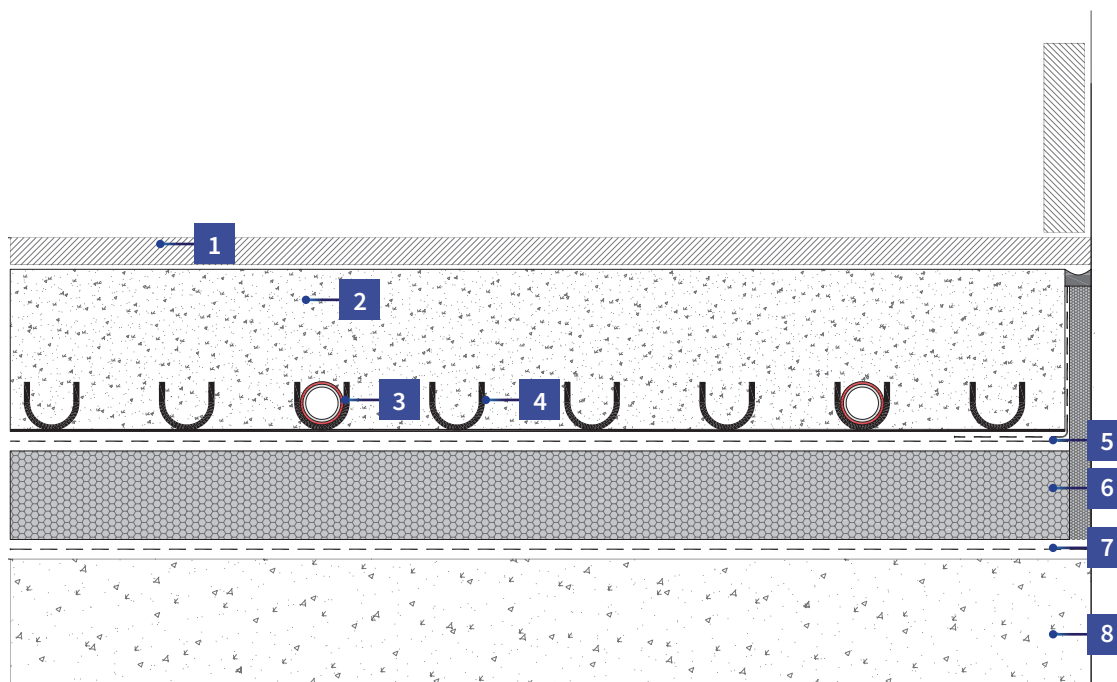

System Description

The Metro™ Rails are laid perpendicular to the planned pipe direction.

Their backing is peeled off and they self-adhere to the floor, starting 200mm off of the wall and then laid parallel at 1m intervals thereafter.

The pipe is then clipped in place before a layer of screed is laid over the pipes to complete the floor.

Features

It is recommended that the Metro System, is installed directly over a layer of insulation, such as the Warmup Metro Insulation.

However the Metro System is also perfect for incorporating UFH into a breathable floor, which may not include conventional insulation.

Where the rails cannot adhere themselves to the sub floor they have holes which support mechanical fixings.

Technical Information

Warmup Metro Insulation is available in a range of thicknesses from 25mm to 100mm in both EPS and PIR variants to help your project comply with building regulations.

The clips on the Metro Rails enable pipe to be installed at any spacing, in multiples of 50mm, with flow and return pipes installed at 25mm centres by staggering a pair of rails.



CASE STUDY: Shree Laxmi Temple, Birmingham

The Warmup Metro Rail system was specified for use within the Shree Laxmi Temple because of the speed and precision that could be achieved when fitting the Warmup pipe through the large rooms.

The pipe was clipped into the Metro Rails which were laid over Metro PIR insulation and an accompanying DPM Layer.

The PIR insulation helped achieve an efficient and comfortably heated temple that will be enjoyed by many people for generations to come.



View on our website

For complete case studies visit:
www.warmup.co.uk/case-studies/

Warmup® Nexxa™ System Panel System

The Warmup® Nexxa™ Panel System enables the most precise installation of underfloor heating within a floating screeded floor.

Regular castellations grip the pipe, preventing both horizontal and vertical movement, and allowing any future floor fixings to be made with confidence.

Because the Nexxa Panels regularly constrain the pipe, the additional 5mm of screed that is normally required to ensure suitable screed coverage over the pipe is no longer required.

This will affect all screeds, but for a calcium sulphate screed, which requires a minimum cover of 25mm over the pipework, this reduces the screed depth by 10%.

The castellations themselves further reduce the volume of screed required taking the total reduction to almost 20% using the previous example.

Reducing the volume of screed not only reduces the structural load on the building and the cost of the screed, it also creates a more responsive heating system, reducing an area's heat loss outside of its utilised hours.

FLOOR CONSTRUCTION

- 1 Floor finish
- 2 Screed
 - 65-75mm Sand and Cement Screed, or
 - 35-45mm Proprietary screed
- 3 Warmup 16mm pipe
- 4 Warmup Nexxa Panel
- 5 Warmup Nexxa Insulation
- 6 Damp Proof Membrane (DPM)
- 7 Subfloor

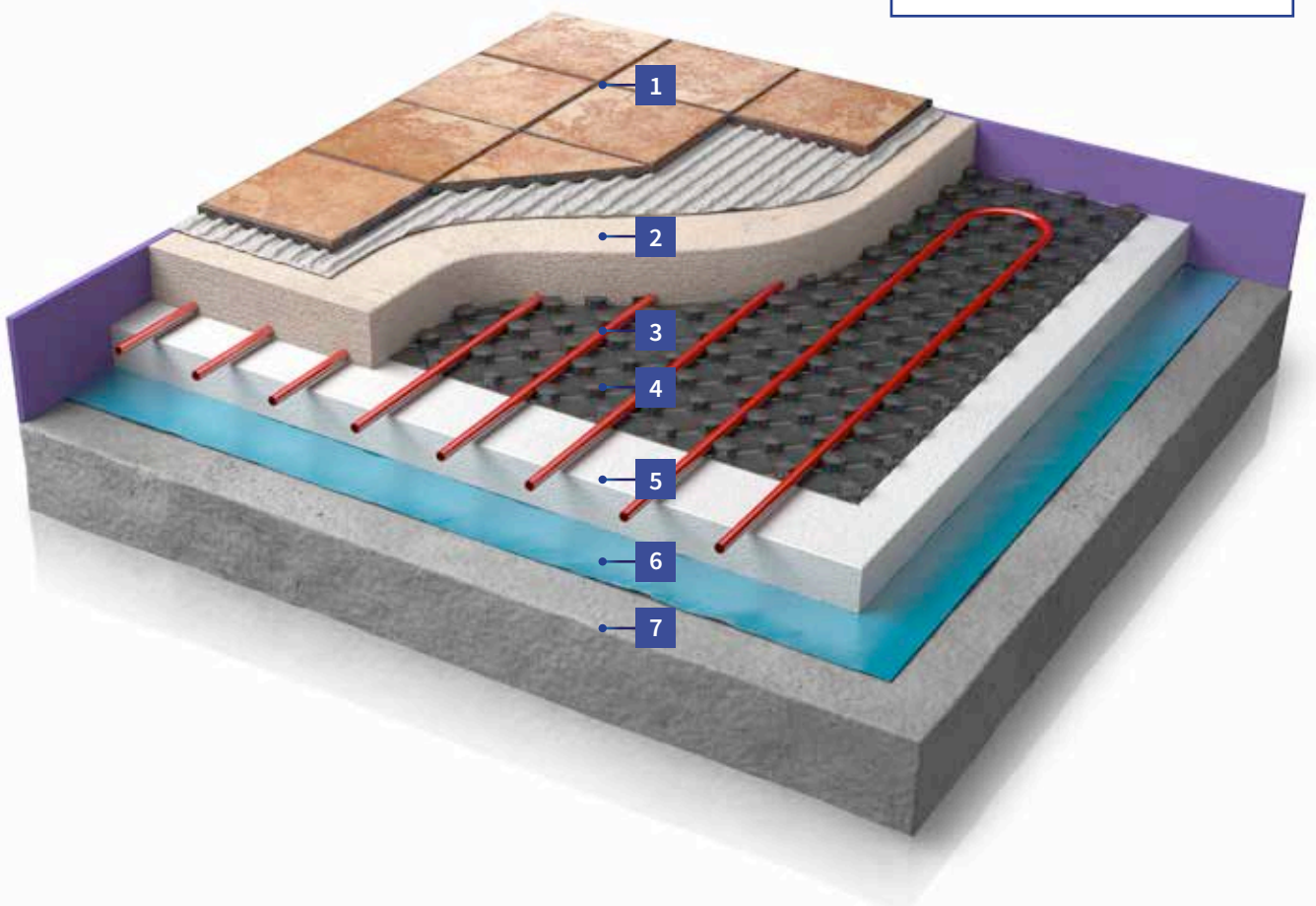

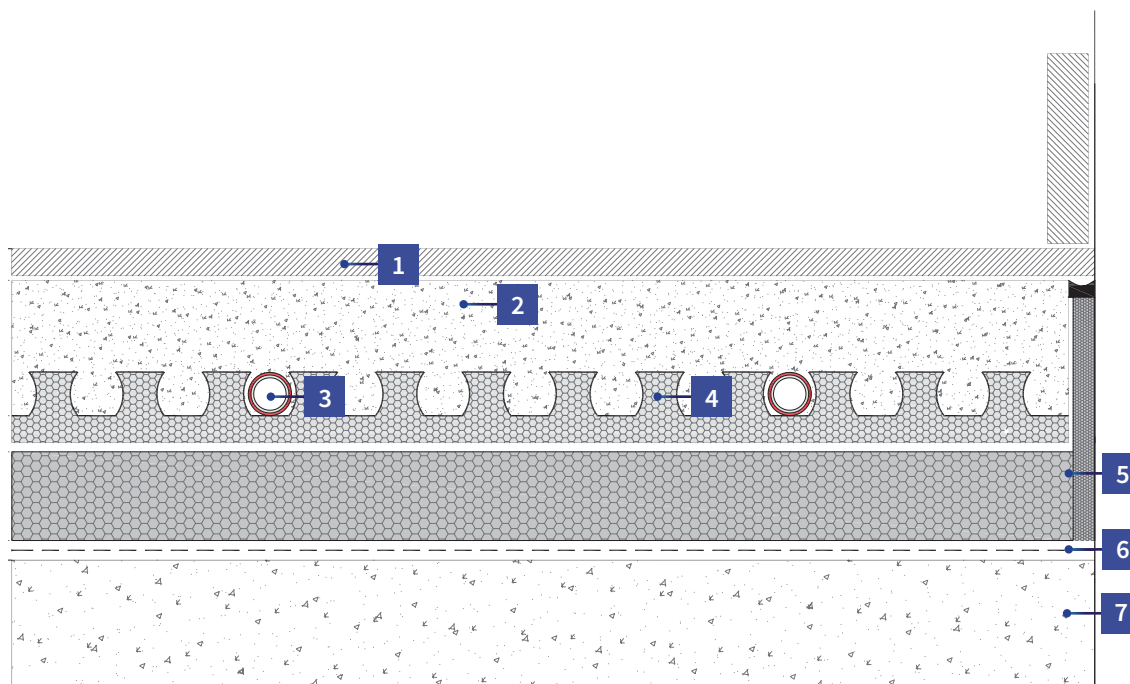

System Description

The Nexxa™ Panels are laid over the insulated sub floor, overlapping and interlocking each panel with the next to create a continuous layer.

Once the floor is fully covered the pipe is clipped into place.

A layer of screed is then laid over the pipes and Nexxa Panels to complete the floating screeded floor.

Features

The continuous layer of interlocked panels removes the need for a separate DPM to protect the insulation during the application and drying period of the screed.

In addition, a laminated backing of 10mm EPS insulation provides added strength to the panels and ensures a rapid response to heating demand.

Technical Information

BS EN 1264:4 requires that the underfloor heating pipe is installed with less than a +/- 10mm deviation from the installation plans and that less than a 5mm vertical movement is possible during screeding.

This is to ensure the pipes position and the systems performance is known.

While it is possible to achieve this with other systems, none make it as easy.



CASE STUDY: Casa Tara, Marbella, Spain

Warmup's Nexxa Panel system was installed in 5 bedrooms when a major renovation was undertaken through this traditional Spanish Villa.

Insulated Nexxa panels were chosen for their ease of installation and the shallower screed required.

Warmup's electrical heating mats were also installed in two dressing rooms and 6 bathrooms, as part of this hybrid underfloor heating solution.



View on our website

Warmup® Contura™ System Floating Floor System

The Warmup® Contura™ Floating Floor System insulates and heats dry construction floating floors.

Floor finishes can be laid immediately over the Contura System unlike screeded floors, which require weeks for the screed to cure and then dry out.

Replacing a traditional screed with thinner and lighter dry flooring panels significantly reduces the heated floor mass.

Consequently the Contura System responds faster to heating demands than traditional screeded systems.

This faster warm up and cool down time is recognised within SAP, with the calculated energy usage reducing as a result.

The reduced system mass also has other benefits, especially for multi-storey developments.

The reduction in weight, associated with moving from a screeded floor to a dry floor, can have a significant impact on the structural requirements of a building, leading to cheaper foundations and structural elements throughout the project.

FLOOR CONSTRUCTION

- 1 Floor covering
- 2 Floating floor deck
- 3 Warmup 16mm pipe
- 4 Warmup Diffuser Plate
- 5 Warmup Contura Panel
- 6 Damp Proof Membrane (DPM)
- 7 Subfloor

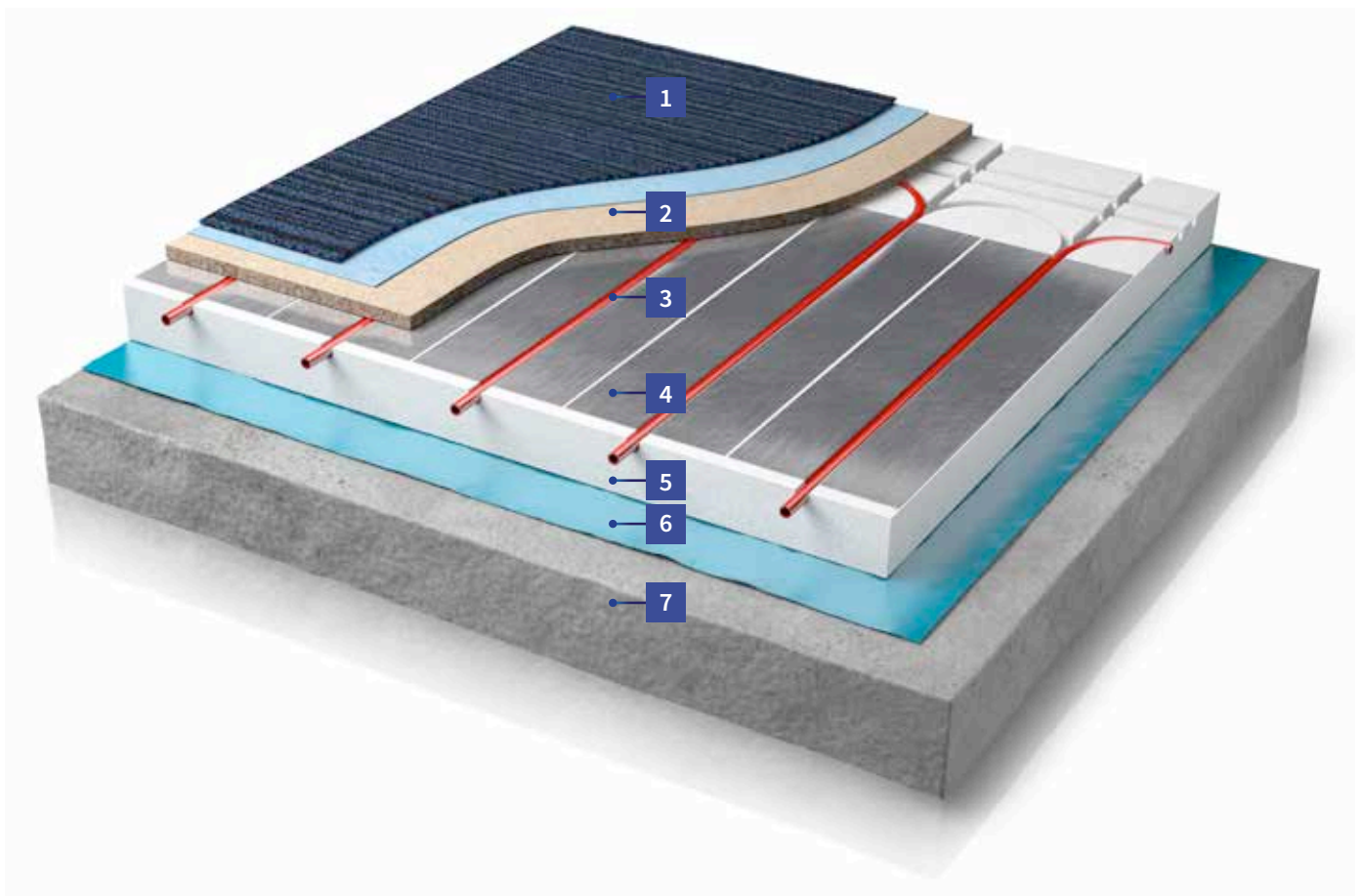

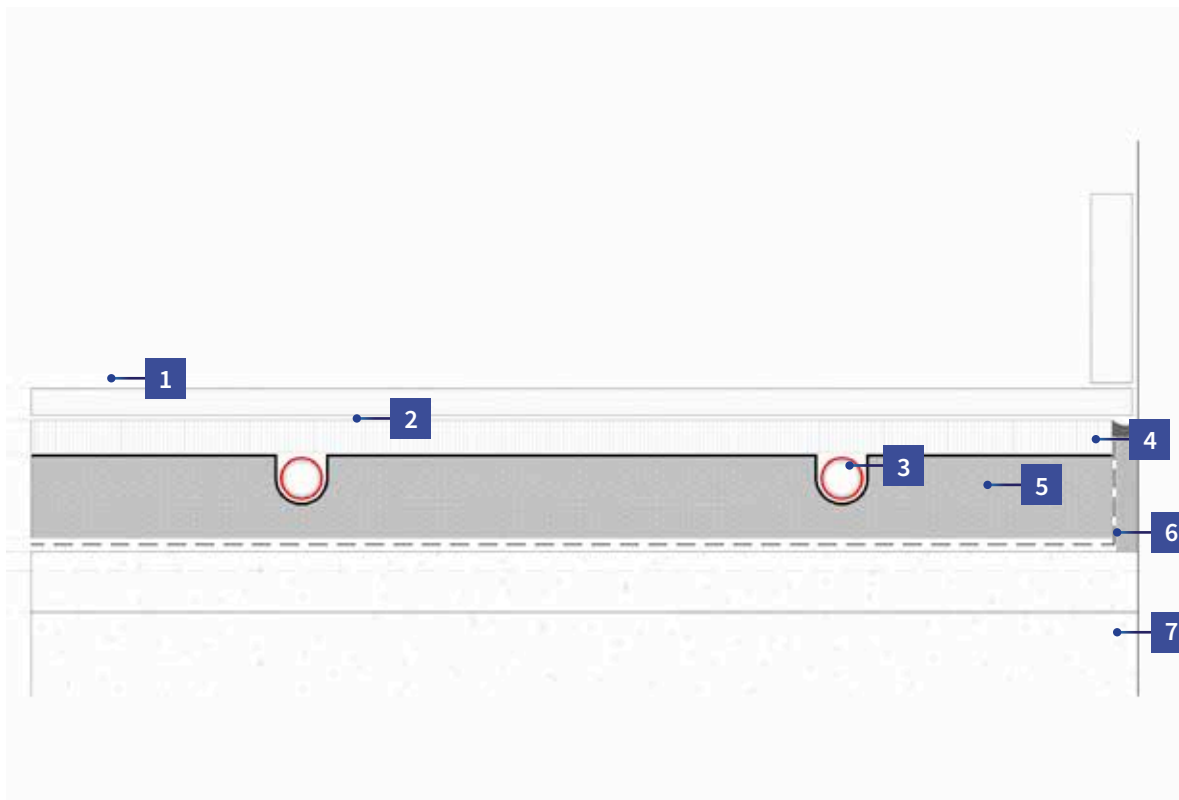

System Description

The Contura™ panels are laid over a flat and level sub floor. Camber from pre cast concrete planks or ridges from beam and block floors are removed by a levelling layer before installation.

Once the pre-formed insulation panels are laid, the diffuser plates and pipe are fitted into place.

A dry floating floor deck is then laid, either as the final floor finish or as a structural layer ready to accept the floor finish.

Features

The Contura system is a completely dry system. By eliminating the need for screed there is no waiting for a screed to dry.

While a screeds drying process can be gently accelerated by using the installed UFH, the curing period must be waited out.

Consequently the Contura System completely removes the 2-4 week wait before the floor finish can be fitted.

Technical Information

Contura Panels are available in a range of thicknesses to suit insulation requirements.

The thinnest version is 30mm thick and it provides enough thermal resistance to be used as the sole thermal insulation layer within separating floors.

The range then increases in thickness with 10mm increments up to a 100mm thick version, allowing the system to be tailored to building regulation requirements.



CASE STUDY: Putney Plaza, London, UK

The acoustic solution being employed within the Putney Plaza development lent itself to the seamless integration of the Warmup Contura System.

The Warmup Contura™ floating floor system involved no screeds or wet trades, reducing the installation time that needed to be allocated to the floor and shortening the planned schedule.

The Warmup 4iE Smart Wi-Fi Thermostats completed the installation.



View on our website

Warmup® Silva™ System

Battened & Joisted Floor System

The Warmup® Silva™ System is designed for use within either battened or suspended timber floors that are constructed using traditional joists.

This cost effective solution allows for flexible installation of pipework, accommodating varying batten or joist centres with ease.

The crafted installation approach of the Silva System is very accommodating to irregular batten and joist spacings.

Normally only 25mm of screed would be required to diffuse the heat efficiently throughout the floor construction, but the thickness of the screed can be increased if desired, making it better suited to storage heating than other solutions.

For existing suspended floors, where either the Joists or the supporting structure is incapable of accommodating the additional load of the screed, the Warmup Tectora System is recommended.

The low mass aluminium diffusers used within the Tectora system diffuse the heat quickly and efficiently to create a responsive underfloor heating system.

FLOOR CONSTRUCTION

- 1 Floor covering
- 2 Screed (25 to 50mm)
- 3 Warmup 16mm pipe
- 4 Warmup Clypso™ Clip
- 5 Warmup Clypso™ Insulation
- 6 Plywood supporting layer
- 7 Supporting battens
- 8 Timber joists

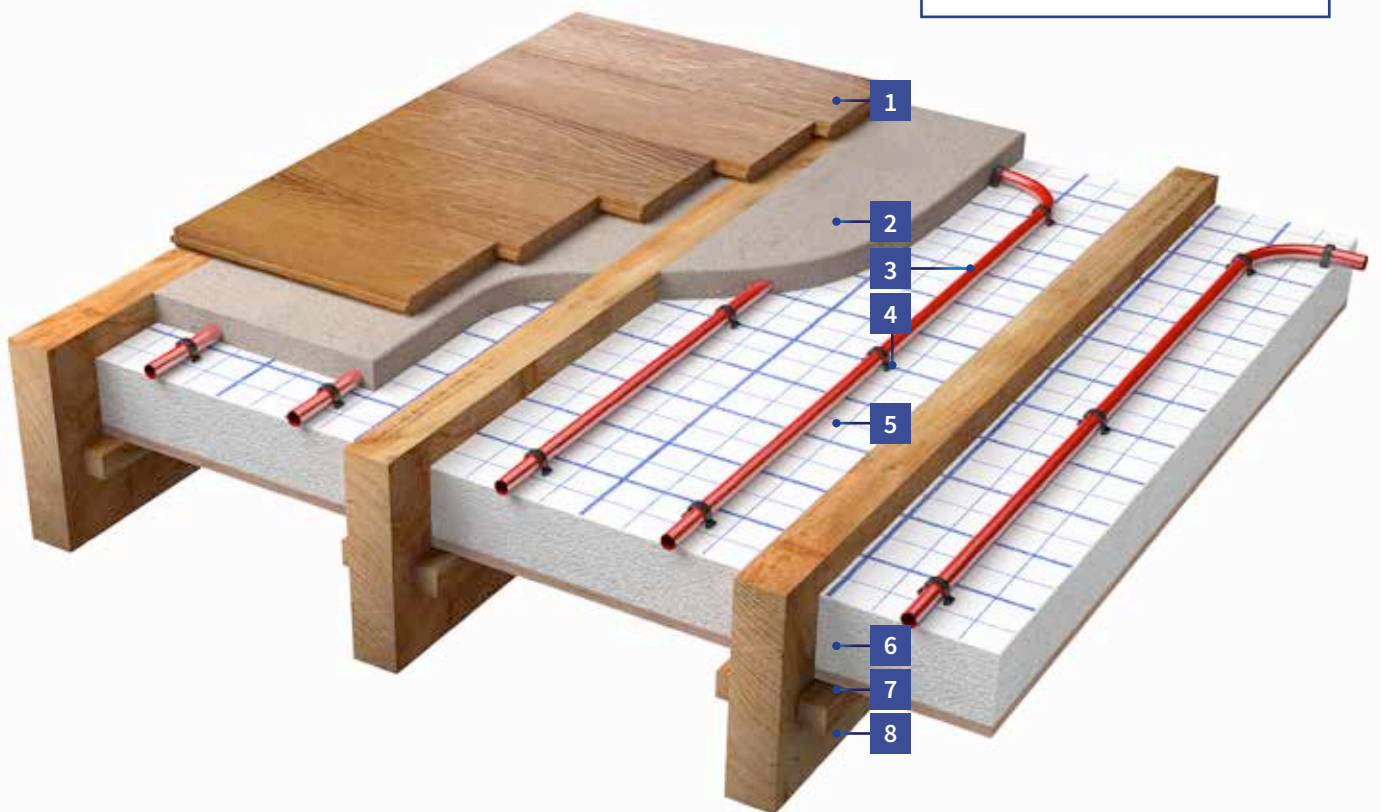

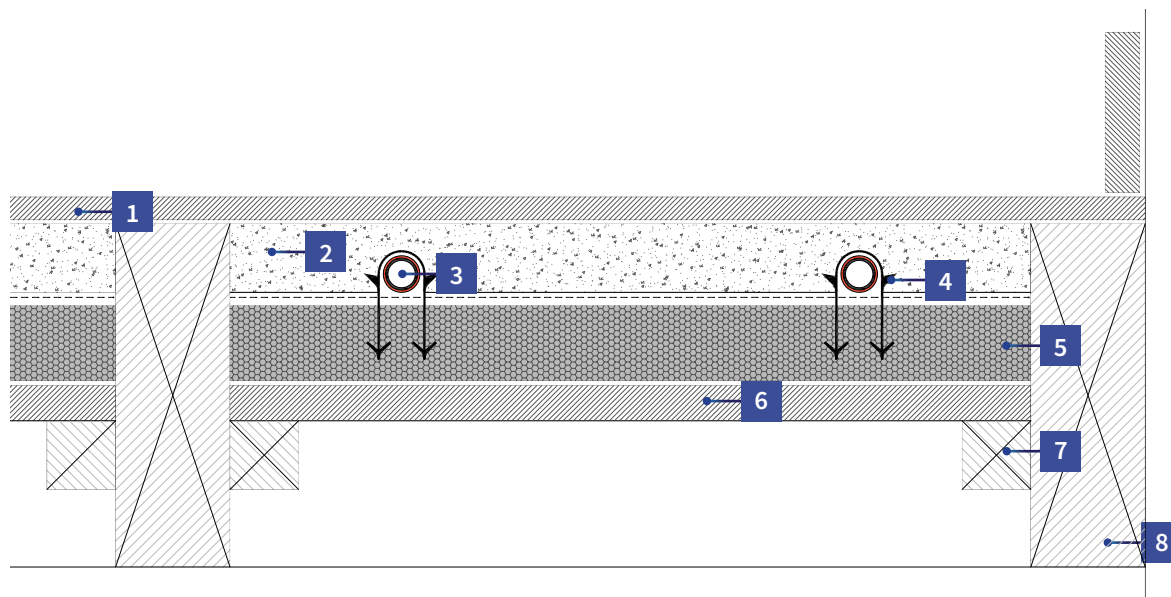

System Description

The Silva™ System uses Clypso™ Clips to fix the pipework to a rigid layer of insulation between the battens or joists.

In joisted constructions, the insulation is supported by a plywood sheet, fixed at a suitable depth between the joists to accommodate the insulation and the 25-50mm of screed.

The floor deck can be laid once the screed has fully dried.

Features

It is recommended that the Warmup Clypso Insulation Panels are used as part of this systems package.

The 50mm x 50mm grid marked on the reinforced PE top surface aids installers in accurately fixing pipes in position, whilst also providing a more robust fixing surface for the Clypso Clips.

Technical Information

The Clypso™ Insulation Panels are available in a range of thicknesses from 25mm to 100mm, with a thermal conductivity of 0.022W/mK.

Careful consideration should be given to the static load added to a suspended timber floor by the screed.

The joists, the plywood base layer and their supporting structure must be sized accordingly.



CASE STUDY: Refurbishment, Twickenham

The Warmup® Silva™ system is a traditional way to heat a home with underfloor heating, when it has suspended timber floors.

When the floors at this house in Twickenham were lifted, the Warmup Silva system was fitted with a 50mm dry mix screed that was laid over it and raked off level with the top of the joists.

The system now provides a steady comfortable heat throughout.



View on our website

Warmup® Tectora™ System

Battened & Joisted Floor System

The Warmup® Tectora™ System is designed for use within either battened or suspended timber floors, including TJI joist constructions.

The aluminium diffuser fits perfectly across two battens, or joists at 400mm centres to create responsive heating system.

The Tectora Diffuser Plates are ideal for timber floors. There are no wet trades involved and consequently, no waiting for the installation to dry before the floor can be completed.

They are lightweight and easy to install, creating a responsive, efficient underfloor heating system with an even heat distribution.

The Warmup Econna™ system is recommended for installations over irregularly spaced battens or joists.

This is because they span over the top of the joists or battens rather than fitting between them. Therefore any changes in spacing are accommodated with ease and have no impact on the system performance.

FLOOR CONSTRUCTION

- 1 Floor covering
- 2 Tectora diffuser plates
- 3 Warmup 16mm pipe
- 4 Warmup Insulation
- 5 Supporting battens
- 6 Timber joists

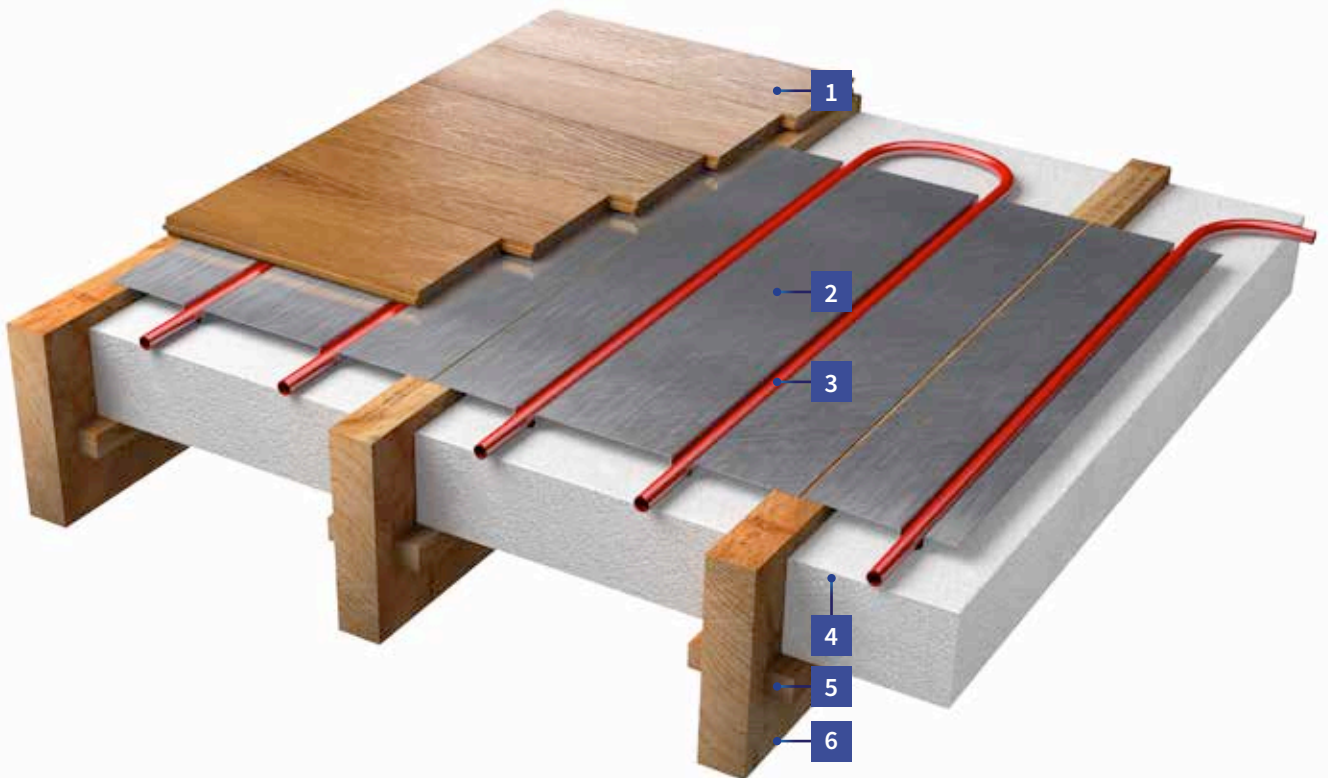

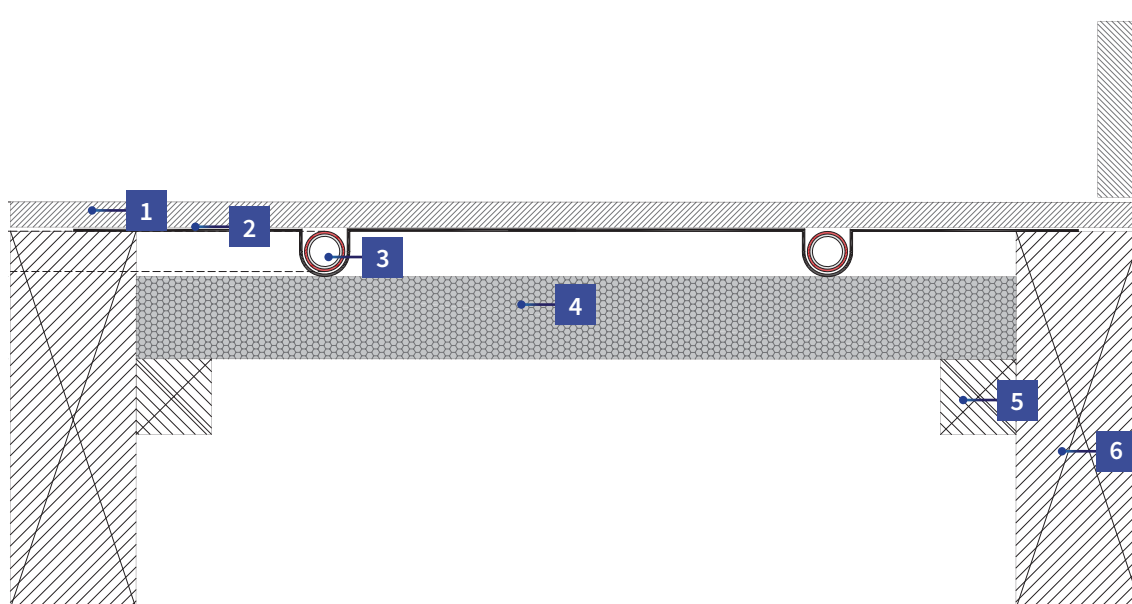

System Description

The space between the battens or joists is insulated with rigid insulation, leaving an airtight 16mm gap between the top of the insulation layer and the top of the battens or joists.

The Tectora™ Diffusers are then fixed to the top of the battens or joists, supported by the insulation layer as they span between them.

The pipe is inserted into the channels before the floor deck is laid.

Features

The Tectora Diffuser Plates are highly conductive and efficiently diffuse the heat across the underside of the floor deck to create an even surface temperature.

Their low mass within an insulated construction makes them responsive to heating demands, reducing heat losses within intermittently heated spaces.

Technical Information

The Tectora diffuser plates are 390mm wide and can be installed within a floor which has an edge to edge, batten or joist, spacing of up to 370mm.

The diffusers therefore easily accommodate the nominal +/- 10mm deviation in spacing within a standard floor construction, using 50mm wide battens or joists at 400mm centres.



CASE STUDY: Ruskin Square, Croydon

The client wanted to ensure an even, comfortable floor surface temperature and efficient heat output with a timber floor fixed over battens.

The Warmup Tectora system was selected and fitted between the timber battens which were installed at 400mm centres.

The aluminium diffusers matched the clients' needs perfectly, heating the floor evenly with cool water, producing an efficient heating system.



View on our
website

For complete case studies visit:
www.warmup.co.uk/case-studies/

Warmup® Econna™ System

Battened & Joisted Floor System

The Warmup® Econna™ System is designed for use over both battened and joisted floors, leaving the void between them free for other services.

The profiled 22mm thick chipboard panels can be installed over battens or joists with spacing's of up to 600mm centres.

The Econna System is ideal for new and old floors alike, but when planning to refurbish an existing floor it can be difficult to know what you will find without lifting up the floor first.

The Econna System is simply installed over the unknown in place of a standard floor deck, rather than competing for space with the other services within the void beneath.

For renovations, where the floor height can be raised slightly, the Warmup® Total-16™ system allows the underfloor heating to be installed over the existing floor deck without the time and cost associated with removing it.

It is especially suited to developments where there are multiple floor constructions as the same system can be used throughout

FLOOR CONSTRUCTION

- 1 Floor covering
- 2 Warmup 16mm pipe
- 3 Warmup Diffuser Plate
- 4 Warmup Econna Panel
- 5 Joists or battens
- 6 Insulation

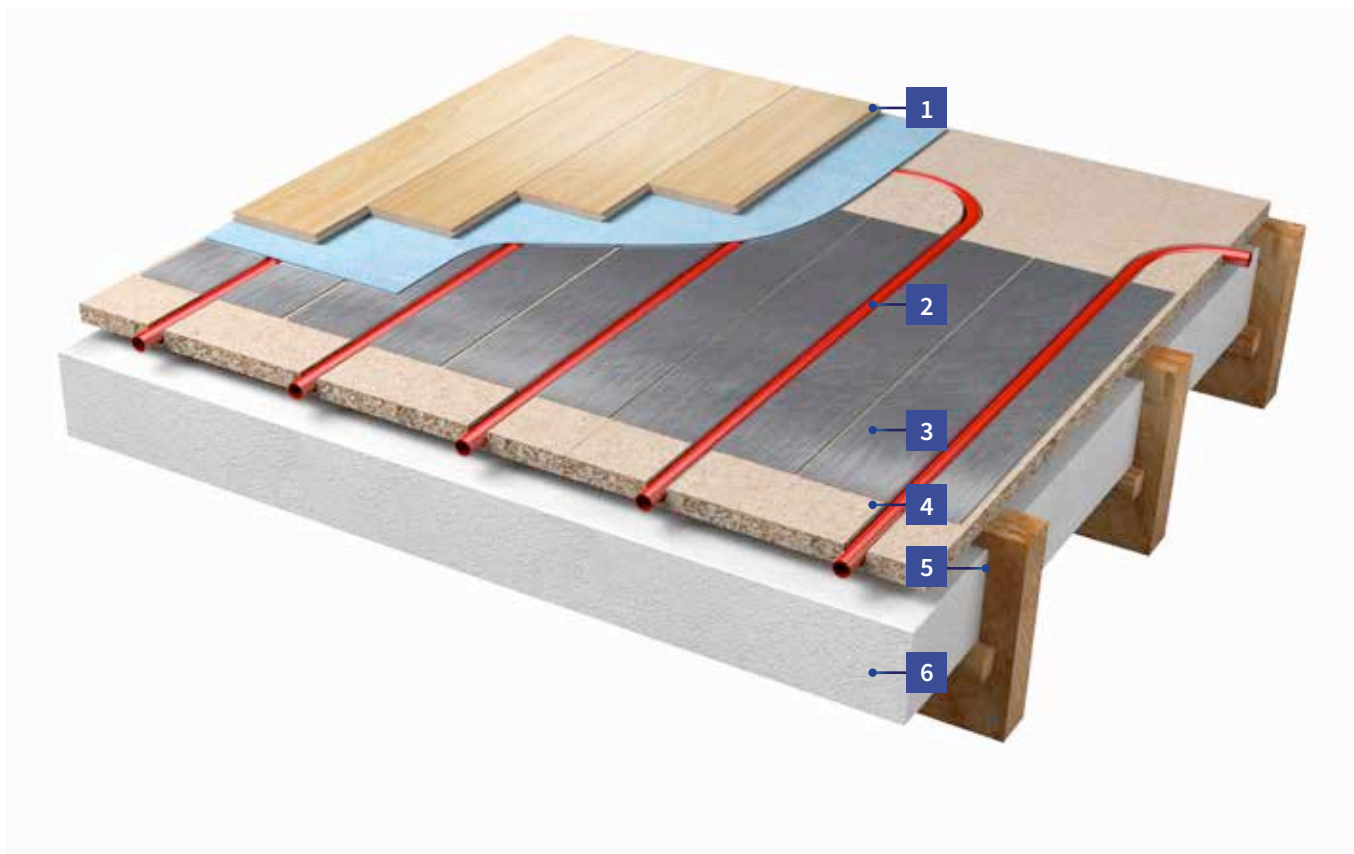

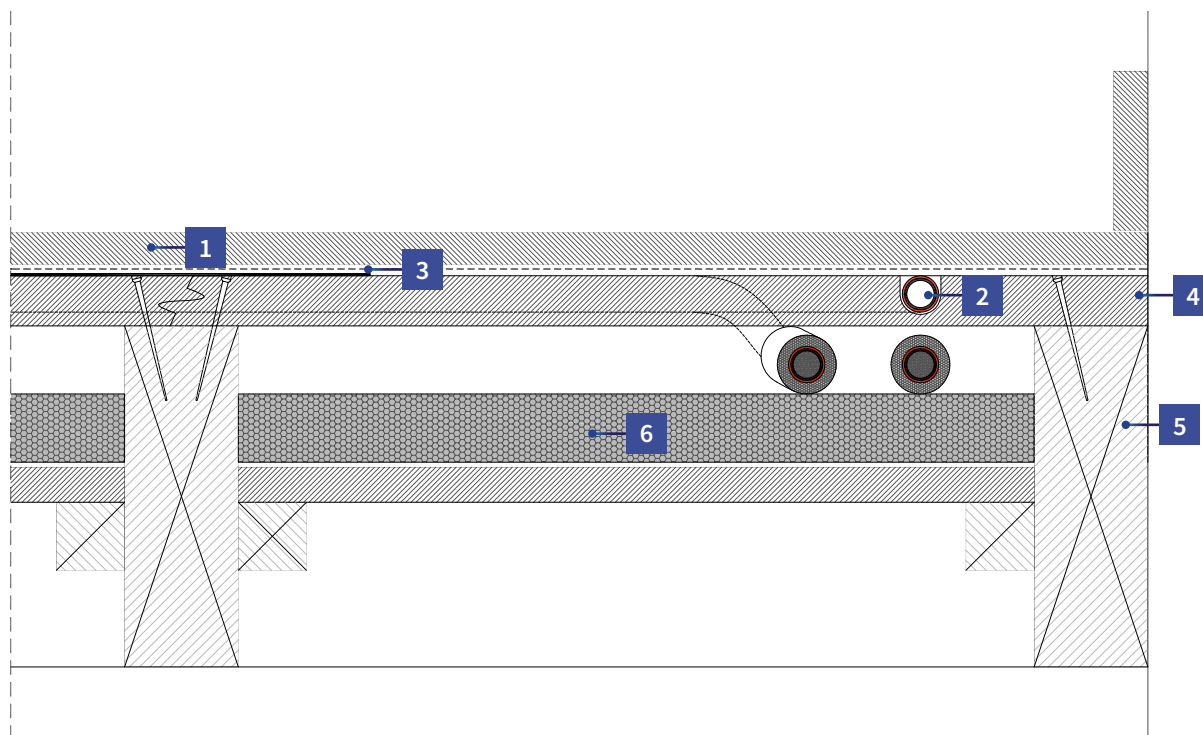

System Description

The space between the battens or joists is insulated to promote system efficiency.

The Econnal™ panels are glued and screwed to the Battens or Joists below to form a structural deck, first fitting the end panels over the first joist bay along opposing walls, before laying the straight panels between them.

The aluminium diffuser plates and the pipes are then inserted into the channels before laying the floor covering.

Features

With the pipe and diffuser plates installed so close to the surface within a structural layer, the resistance to the heat flow into the room is very low.

This enables areas to be heated with cooler water, which can be generated more efficiently whilst still achieving the heat output required.

Technical Information

Depending on the floor finish to be applied, an additional covering may be required over the top of the Econnal System.

For example, floors to receive Carpet or Vinyl coverings should first be over boarded with a layer of plywood or similar to create a smooth floor surface and to protect the heating system.

Engineered timber floors would normally be laid directly over the Econnal system with a suitable underlay.



CASE STUDY: Refurbishment, London

The Warmup Econnal system was selected for this refurbishment as the system could be laid directly over the existing joists.

The old floor deck was lifted and mineral wool insulation fitted between the joists before the Econnal system was laid in place.

An engineered wood floor finish and its underlay were laid directly over the top to complete the floor without introducing any wet trades.



View on our
website

For complete case studies visit:
www.warmup.co.uk/case-studies/

Warmup® Manifold

The Warmup® Manifold is manufactured from stainless steel and provides water regulation for up to 12 underfloor heating circuits.

Adding the Warmup Mixing unit enables the manifold to regulate the water temperature between 35°C and 60°C, for tailored system performance.

The Warmup manifold is engineered for easy installation, commissioning and years of trouble free service, backed up by our 10 year warranty.

Each individual circuit on the manifold has its own flow gauge, allowing the system to be quickly and accurately balanced to provide an efficient heating system.

For zone control, Warmup Actuators are added to each circuit, using just 0.8W each they are amongst the most energy efficient UFH actuators available.

Where required, the mixing unit uses a Grundfos UPS II circulator, in combination with a unique thermostatic mixing valve to provide near silent operation.

MANIFOLD DETAIL

- 1 Flow Gauge
- 2 Air Vent
- 3 Fill/Drain port
- 4 Pipe Connector
- 5 Mounting Bracket
- 6 Electrothermic Actuator
- 7 Isolation Valve
- 8 Thermostatic Mixing Valve
- 9 Grundfos UPS2 Circulator

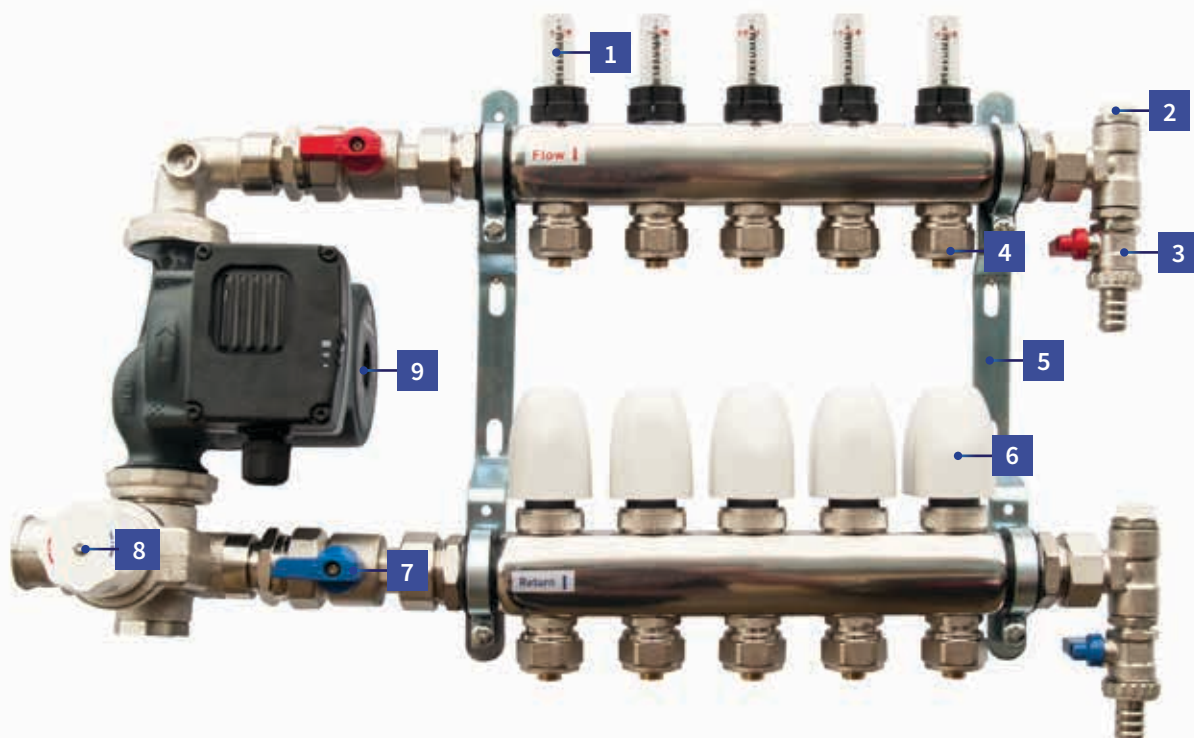

Warmup® Pipe

The Warmup® PEX-A Pipe is formed as a single extrusion with an adhesive layer and EVOH oxygen barrier.

The EVOH layer restricts the ingress of oxygen into the heating system, reducing oxidation of critical components in the primary system and extending their service life.

The minimum 70% cross linking within the PE material provides superior mechanical properties to the pipe, with a maximum working temperature and pressure of 95°C and 6 bar respectively.

With all UFH systems operating at less than 60°C and with a typical working pressure of just 1.5bar, the lifetime warranty we give on our pipe seems unnecessary.

Our pipe material has a high thermal conductivity of 0.41W/mK, substantially greater than an equivalent polybutylene pipe at 0.22W/mK.

This enables our systems to emit between 3% and 6% more heat for the same water temperature as equivalent systems using PB pipe. Or, what is more likely, use water up to 6% cooler so that the heat source can operate more efficiently.

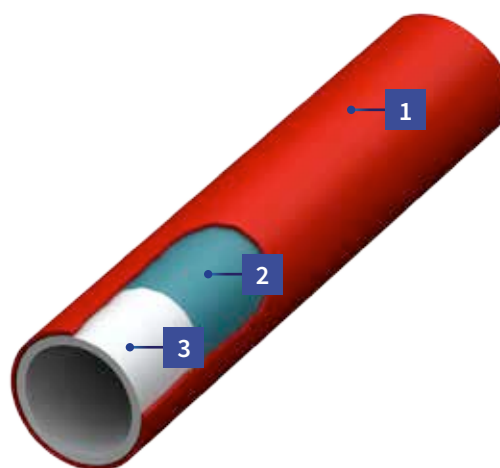
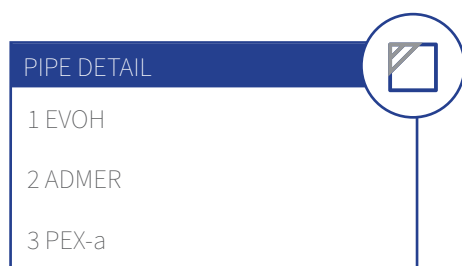

Insulation

Insulation is a critical component of an underfloor heating system. Building Regulations Part L has significantly reduced the fabric heat loss of buildings over the last 20 years and it's now common to see 100-150mm of insulation installed within the ground floor of a house.

It's important to remember that Part L requires insulation within separating floors between dwellings too though!

Warmup supplies both Expanded Polystyrene (EPS) and foil faced Polyisocyanurate (PIR) insulation.

With an Ozone Depletion Potential, ODP=0 and a Global Warming Potential, GWP<5 our products achieve a BRE Green Guide A rating.

Available in a variety of thicknesses and with exceptionally low thermal conductivities, our insulation will help you achieve Part L Compliance.

When used with our Clypso™ or Silva™ systems, we provide a variation of the same insulation, with the top surface covered by a woven fabric, designed to provide superior retention of the Clypso Clips.

The fabric is also printed with a grid, making installation of the Clypso™ and Silva™ systems easier, faster and more precise.

Warmup[®] Electric Systems

Warmup provides electric underfloor heating systems for use as both primary and secondary heat sources within a zone.

The heating systems use the most technically advanced, 2mm thick fluoropolymer coated cable that will operate, maintenance free, for the lifetime of the floor.

Our low mass, responsive electric underfloor heating solutions help to achieve excellent energy efficiency, making them suitable for use in new builds, refurbishments and renovations.

They can be installed under a wide range of floor finishes, including tile, vinyl, laminate, timber and carpets.





Warmup System Selection Guide

Warmup® Electric Systems

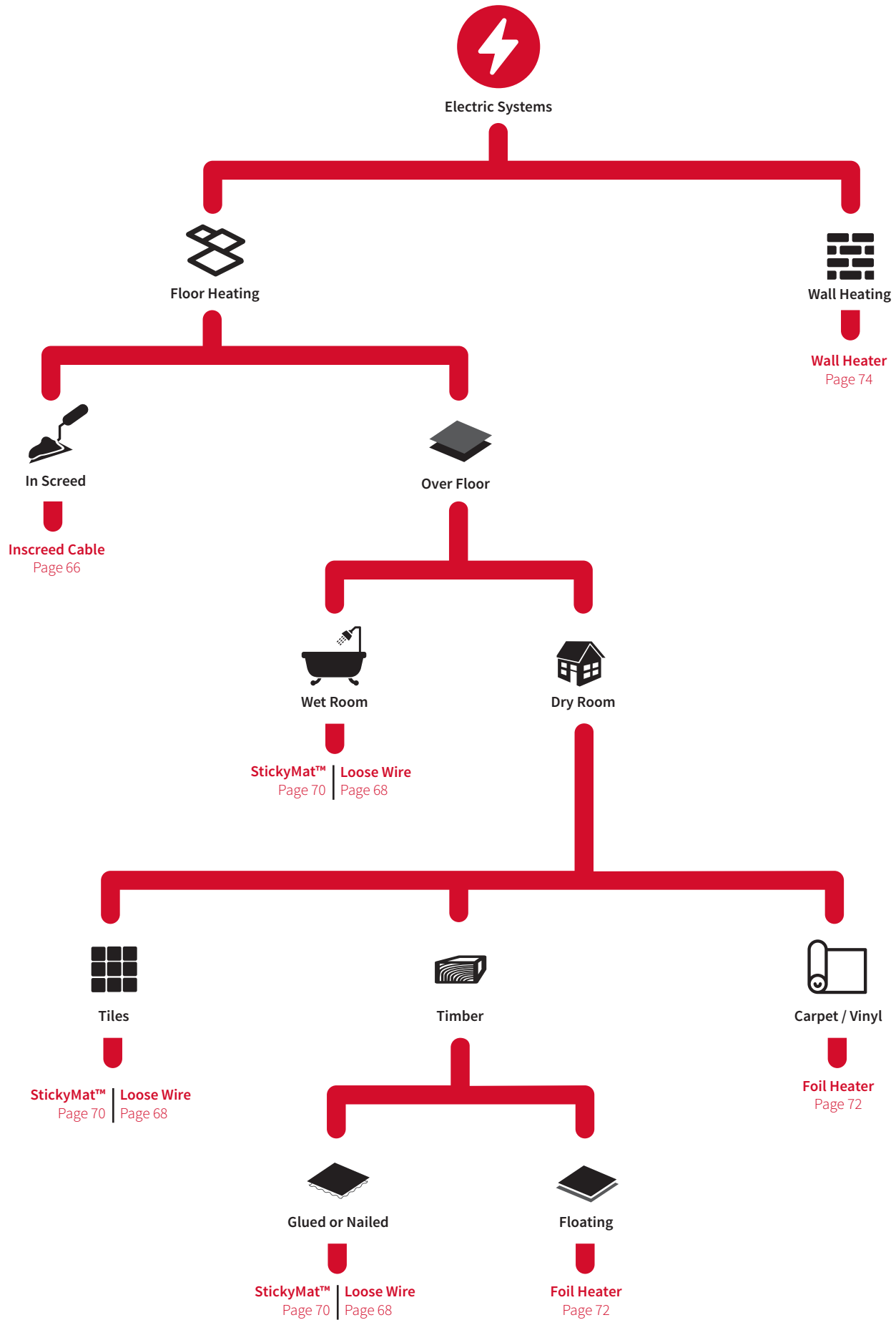

Warmup® Inscreed Cable System

Screeded Floor System

The Warmup® Inscreed Cable System is designed for use within a screeded floor construction.

The variable spacing of the cable available during design and installation allows the system power to be tailored to the properties requirements.

The Inscreed Cable system is extremely versatile. Its spacing can be varied to tailor the heat input into a floor to match its required heat load.

This makes it ideal for screeds as thin as 50mm laid over insulation when a responsive system is required, as well as thicker, bonded screeds where the floor construction is to be used as a storage heater.

For retrofit installations where the sub floor is already in place, it is recommended that one of the other Warmup Electric UFH Systems is selected based on requirements.

They can all be installed directly between an insulation layer and the floor finish layer to create a system with a very quick response to heating demands.

FLOOR CONSTRUCTION

- 1 Floor finish
- 2 Screed (30 to 50mm)
- 3 Warmup Inscreed Cable
- 4 Warmup Inscreed Rails
- 5 Screed
- 6 Damp Proof Membrane (DPM)
- 7 Insulation
- 8 Damp Proof Membrane (DPM)
- 9 Subfloor

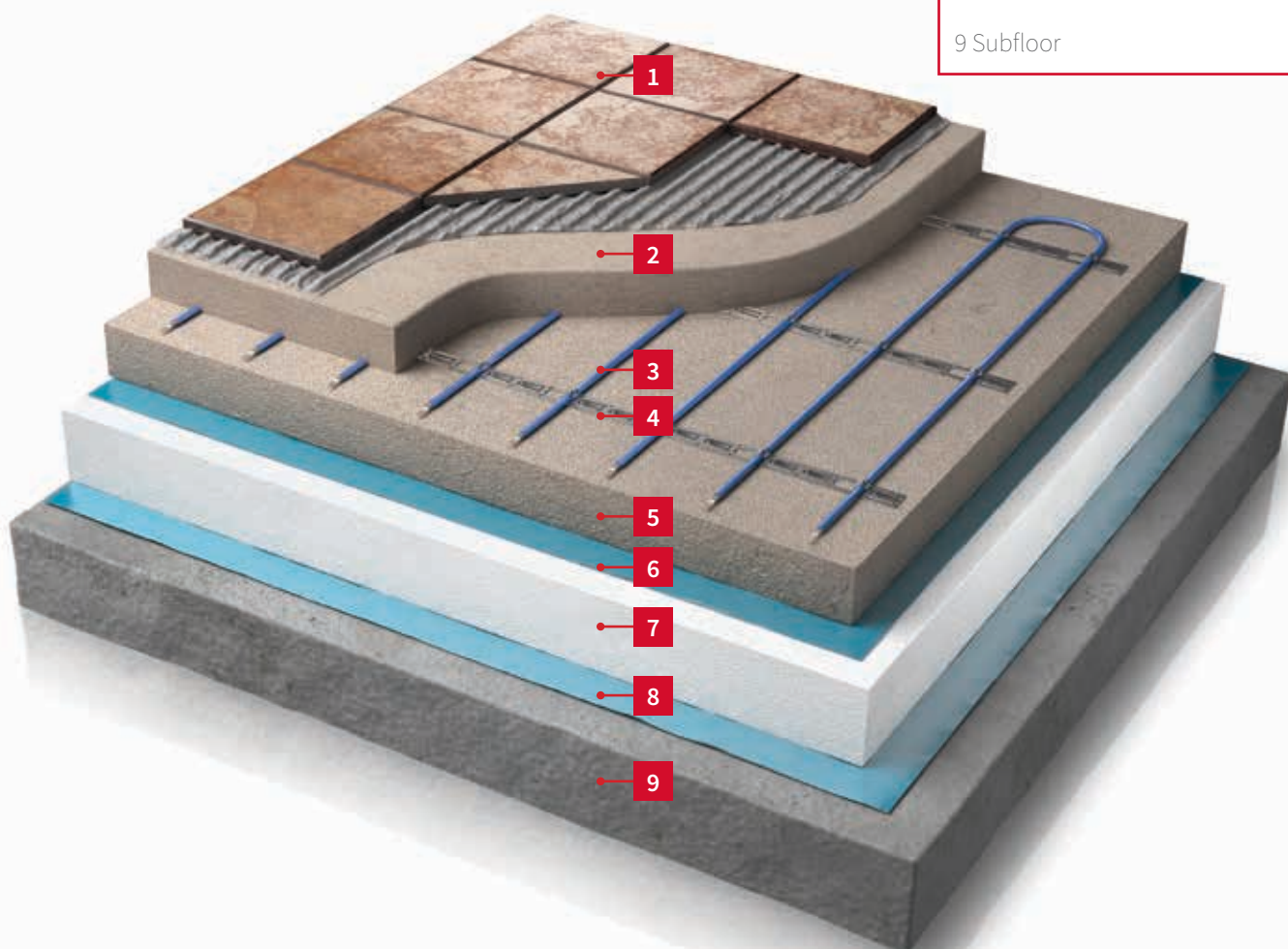

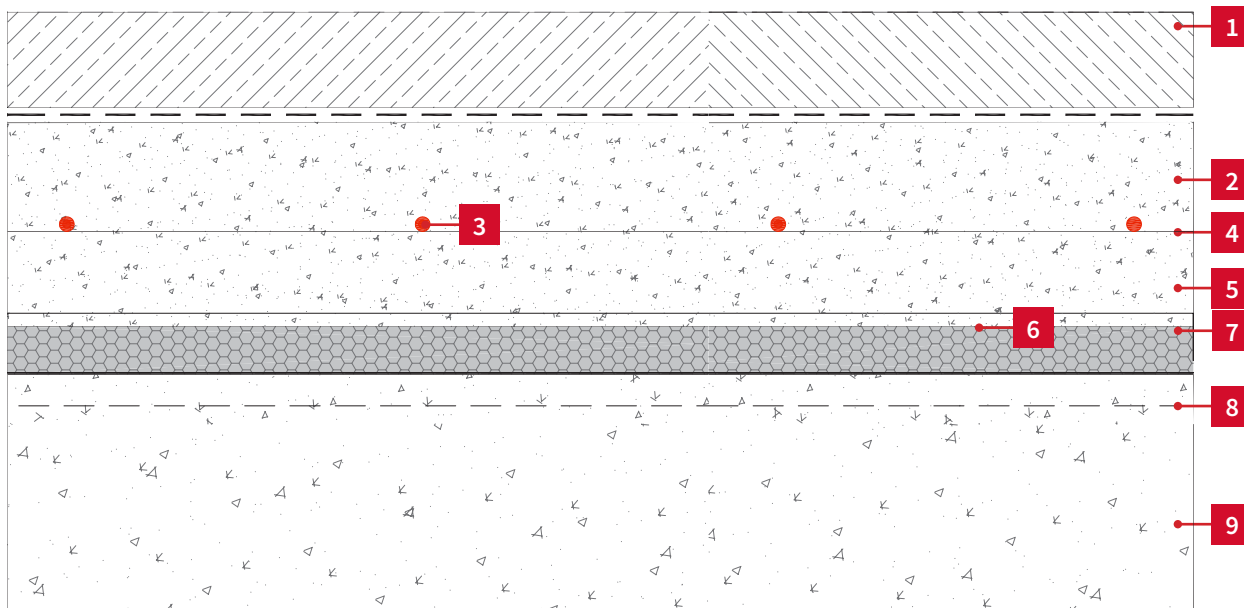

System Description

For a responsive low mass system the metal fixing bands are laid over either foil or cement faced insulation panels that are suitable for use with electric underfloor heating. If a high mass “storage heating” system is required they would be laid over an insulated concrete sub floor.

The cables are then clipped into the fixing bands before laying a screed with a minimum thickness of 50mm, ready for a selection of floor finishes.

Features

Once installed within a screed, this system is suitable for any underfloor heating compatible floor finish, which can be easily lifted and replaced as desired without any risk of damaging the heating system.

Technical Information

The slower heat up and cool down time of the Inscreed Cable System makes it particularly suited to the creation of a storage heating system.

Laid over a concrete base with a thinner bonded screed laid over the system, our controls can be instructed to make use of the low cost energy available on economy tariff supplies.



CASE STUDY: Coq Du Nord/The Roost development, Guernsey, UK

Warmup inscreed cables were installed throughout this brand new development of 12 exclusive 3 and 4 bedroom family homes.

Warmup’s underfloor heating was installed under the hallway’s beautiful oak, rustic brushed and UV oiled bevelled flooring and the underfloor heated wooden flooring continues into the lounge areas.

For complete case studies visit:
www.warmup.co.uk/case-studies/



View on our website

Warmup® Loose Wire System

The Warmup® Loose Wire System is designed for use within the adhesive layer under tiles or within a levelling compound under other floor finishes.

The variable spacing of the cable available during design and installation allows the system power to be tailored to the properties requirements.

The Loose Wire System is ideal for installation within small or irregularly shaped areas.

In a bathroom the cable can be easily installed around the fixtures and within rooms with curved features it can easily follow the contours.

The variable spacing of the cable also allows the heat output to be matched to requirements.

For regularly shaped rooms the Sticky Mat system offers a quick and precise installation alternative to the Loose Wire System.

Alternatively, for floor finishes other than tiles the Foil Heater System offers a completely dry construction that does not require a levelling compound.

FLOOR CONSTRUCTION

- 1 Floor covering
- 2 Tile adhesive or leveling compound
- 3 Warmup Tape
- 4 Warmup Loose Wire
- 5 Warmup Coated Insulation
- 6 Warmup Flexible Adhesive
- 7 Subfloor

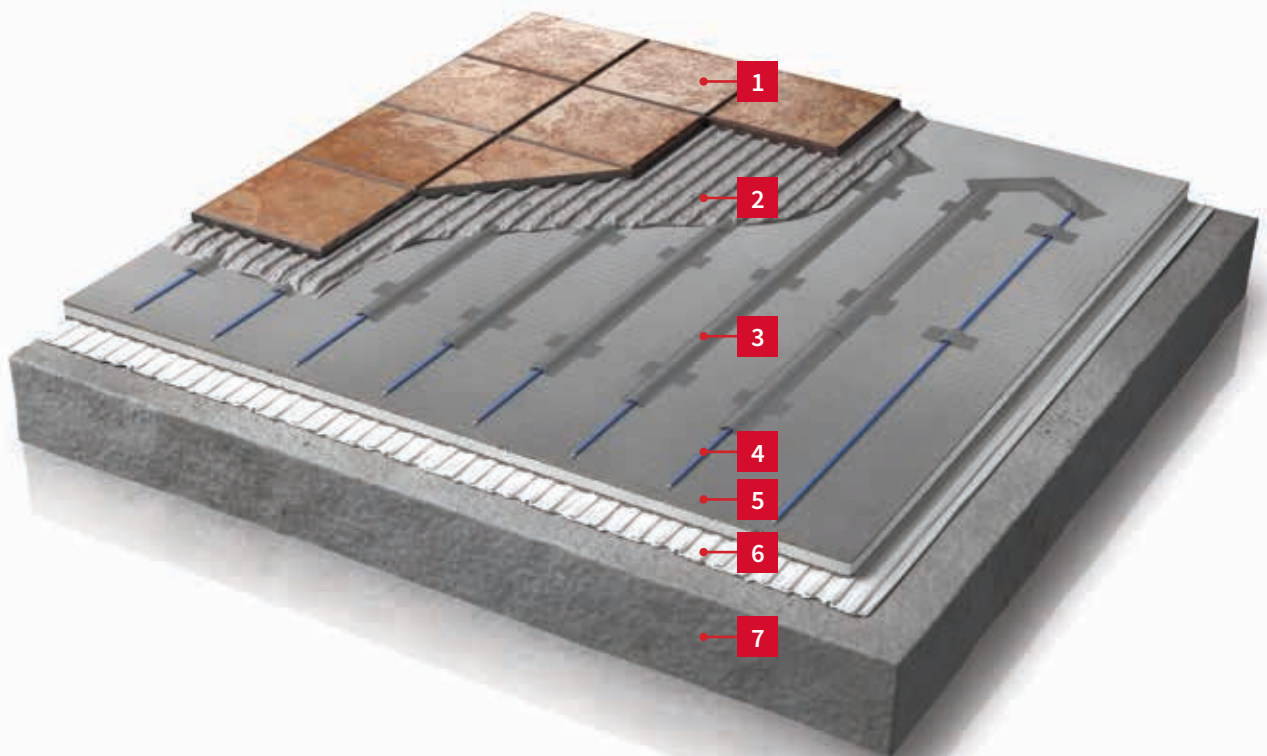

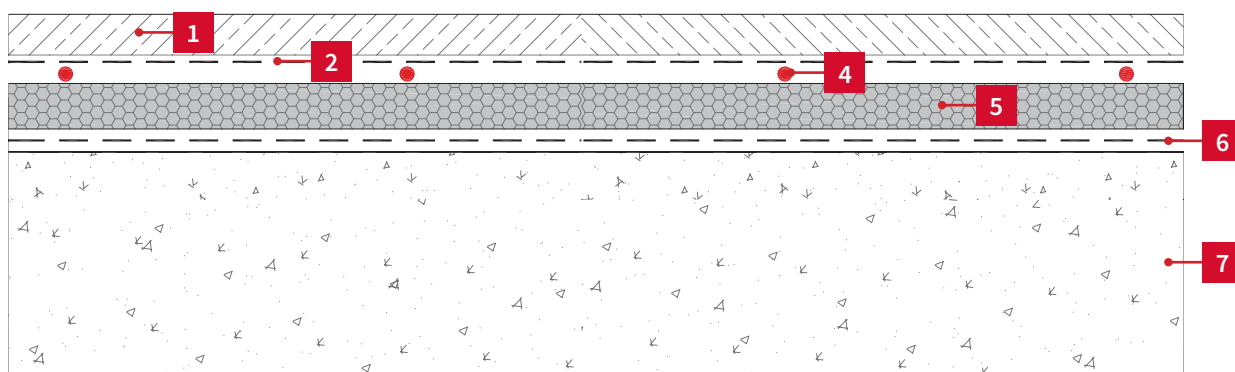

System Description

Once the sub floor is prepared, Warmup Cement Faced Insulation is bonded to it.

The loose heating wire is laid out in accordance with the installation drawing, using 50mm wide tabs of tape to Temporarily hold it in position before being fully taped down.

The tiles are then laid as usual over the insulation and heating cable to create an efficient heating system.

Features

With this system installed directly beneath a tiled floor finish, it can have an exceptionally quick response time.

By warming up and cooling down faster, before and after you use the room, the room is cooler when not in use, losing less heat and saving energy.

Technical Information

The ultra-thin, 2mm multi strand, dual core heating cable, is double insulated with an advanced fluoropolymer making it exceptionally tough and easy to tile over.

With BEAB component approval, this KEMA and GS approved CE marked heating element meets the highest safety standards for ultimate peace of mind.



CASE STUDY: Connaught Hotel, London

Warmup's DWS loose wire system was installed in 95 bathrooms to ensure there would be no cold spots in these very irregular shaped rooms and to be able to provide heating around the fixed furniture. Warmup's loose wire systems was installed over Warmup's 10mm insulation boards which guarantees a rapid heat up time without compromising the floor build up. The underfloor heating systems were linked to a building Management System, which would be activated upon guest check-in to ensure that the floor was warm and welcoming upon arrival.



View on our
website

Warmup® StickyMat™ System

The Warmup® StickyMat™ System is designed for use within the adhesive layer under tiles or within a levelling compound under other floor finishes.

The fixed spacing and self-adhesive mat makes installation of regularly shaped rooms quick and easy whilst ensuring precision is maintained.

The StickyMat System is ideal for installations within regularly shaped areas, where 0.5m wide mats can be quickly rolled out across the floor in parallel runs.

The pressure sensitive adhesive securely binds the mats to the floor, keeping them flat and ensuring the application of tile adhesive is snag free whilst allowing the mats to be easily repositioned as needed.

For floors using a vinyl, carpet, timber or other UFH compatible floor finishes including tiles, the system can be covered with a levelling compound to provide a flat and level floor surface.

Alternatively, the Foil Heater System offers a completely dry construction that does not require a levelling compound.

FLOOR CONSTRUCTION

- 1 Floor covering
- 2 Tile adhesive or leveling compound
- 3 Warmup StickyMat™
- 4 Warmup Coated Insulation Board
- 5 Warmup Flexible Adhesive
- 6 Subfloor

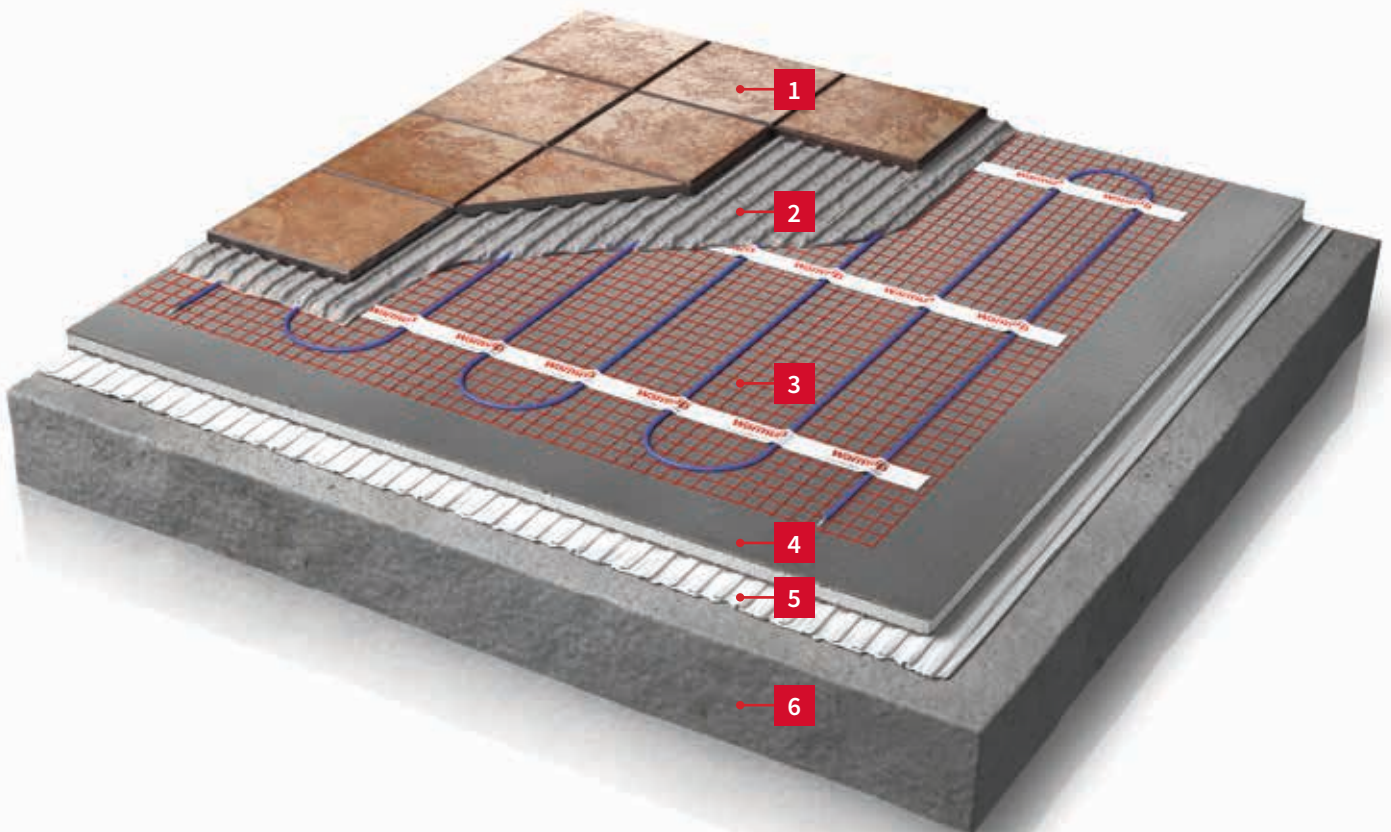

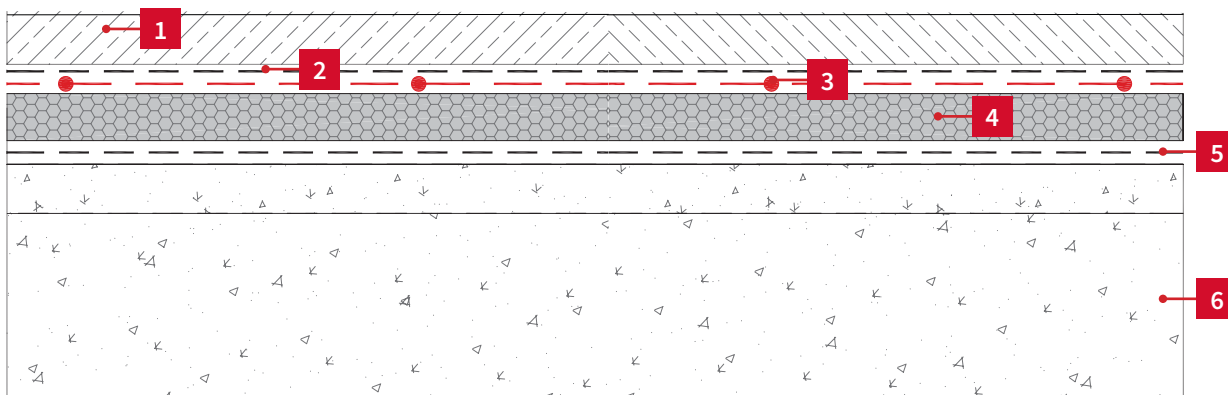

System Description

Once the subfloor is prepared, Warmup Cement Faced Insulation is bonded to it.

The StickyMats™ are then rolled along the length of the area to be heated, being cut and turned at the ends until the heated area is fully covered.

The tiles are then laid as usual over the insulation and the StickyMats™ to complete the floor.

Features

StickyMats are available in both 150W/m² and 200W/m² variants, making them ideal for use as the primary heat source within modern homes and most older properties.

The StickyMat, like the Warmup Loose Wire System, comes with Warmup's Lifetime Warranty to provide complete peace of mind.

Technical Information

The ultra-thin, 2mm multi strand, dual core heating cable, is double insulated with an advanced fluoropolymer making it exceptionally tough and easy to tile over.

With BEAB component approval, this KEMA and GS approved CE marked heating element meets the highest safety standards for ultimate peace of mind.



CASE STUDY: Marathon House, London, UK

The owner of this penthouse apartment wanted to have a heating system that would integrate seamlessly with the modern décor of the apartment and provide outstanding comfort without taking any wall space or restricting the panoramic views over London.

www.warmup.co.uk/case-studies/



View on our website

Warmup® Foil Heater System

The Warmup® Foil Heater System is an electric underfloor heating system for laminate, engineered wood and other floating floor finishes.

The Foil Heater is fitted between the insulating underlay and the floating floor deck, adding negligible height to the installation.

The Foil Heater System is optimised for use under floating timber floors, especially as a direct application under both engineered wood and laminate floors.

Glued parquet flooring, carpets, vinyl's and other resilient floor finishes can be laid over the Warmup Foil Heater by using our Dual Overlay system to create a thin floating floor deck.

When home owners wish to redecorate or refurbish their rooms in the future, the floating floor finish installed over the foil heater can be easily lifted and replaced with a new finish if desired.

The Foil Heater is simply left in place, ready to be used once the project is completed with no additional works required.

FLOOR CONSTRUCTION

- 1 Floor finish
- 2 Warmup Foil Heater
- 3 Warmup insulated Underlay
- 4 Floor deck
- 5 Insulation
- 6 Joists



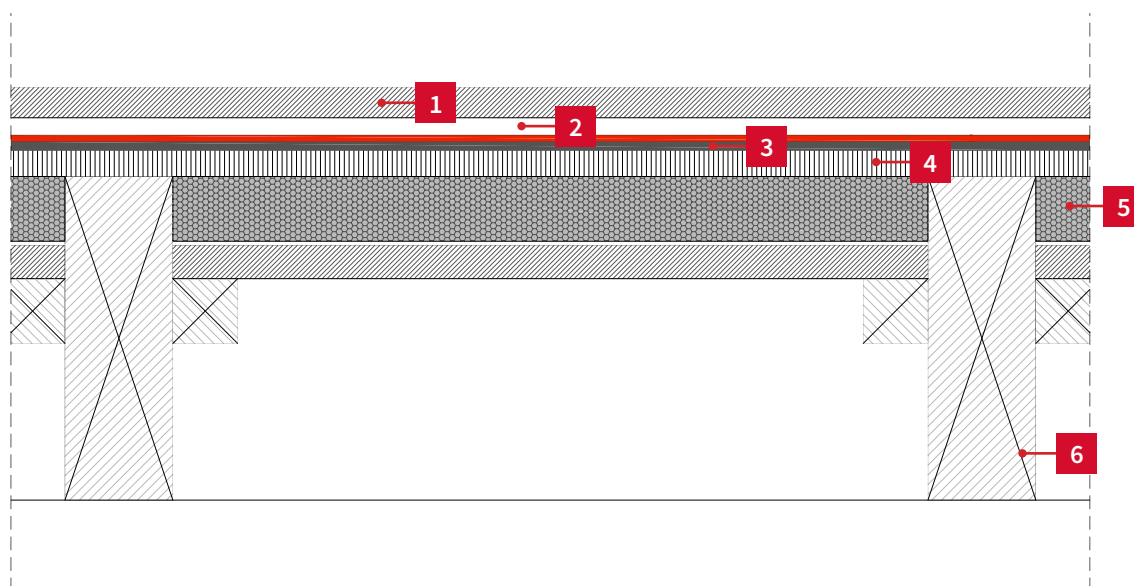

System Description

Ensure that the sub floor is flat and level to a standard suitable for the floating floor finish.

Fit a layer of insulation, such as the Warmup Insulated Underlay, across the floor to insulate and protect the Foil Heater.

The Foil Heaters are then rolled out across the area to be heated before laying the floating floor deck and any potential additional coverings.

Features

The fibre reinforced foil provides a continuous earth layer within the floor construction whilst also diffusing the heat away from the heating cable.

In combination with its integral earth layer the IPX7 rating of the foil heater offers an exceptional level of electrical safety not found in alternatives such as carbon film heaters.

Technical Information

The fibre reinforced foil is wrapped around a thin multi strand, dual core heating cable that is insulated with an advanced fluoropolymer.

This robust combination allows us to offer a 15 year warranty with full confidence in the products performance and its ability to provide years of maintenance free heating.



CASE STUDY: Site J New England Quarter, Brighton, UK

147 1, 2 and 3 bed apartments to Code 5. Electric under floor heating throughout (Foil/WIU/WDO-living areas, PFM/10mm ITBB-bathrooms)

Constructed on the site of the old LB&SC Railway locomotive works on a manmade embankment. The Warmup solution did not need screed, thus reducing the buildings overall weight and avoiding the requirement for extra support pilings providing hundreds of thousands of savings in construction costs.



View on our website

For complete case studies visit: www.warmup.co.uk/case-studies/

Warmup® Wall Heating

The Warmup® StickyMat™ System can be applied to walls as easily as it can be applied to floors, installed within the tile adhesive to provide all round warmth.

The self-adhesive mat bonds itself to the wall off of the roll, fitting within a standard depth layer of tile adhesive.

Wall heating is the ideal solution for rooms with limited floor space to heat, preventing the floor from being the sole source of heat.

This is a scenario common to bathrooms, where the free wall space is often 2-3 times greater than that of the floor, making it much easier to maintain a comfortably warm temperature

When active within a bathroom, the elevated wall temperatures that are heating the room also prevent condensation from forming on them, keeping the room drier and mirrors mounted over them demisted.

What's more, the warm, dry walls starve any potential moulds of the moisture they require to grow.

WALL CONSTRUCTION

- 1 Wall Tiles
- 2 Tile Adhesive
- 3 Warmup StickyMat
- 4 Warmup Coated Insulation
- 5 Warmup Flexible Adhesive
- 6 Wall Structure

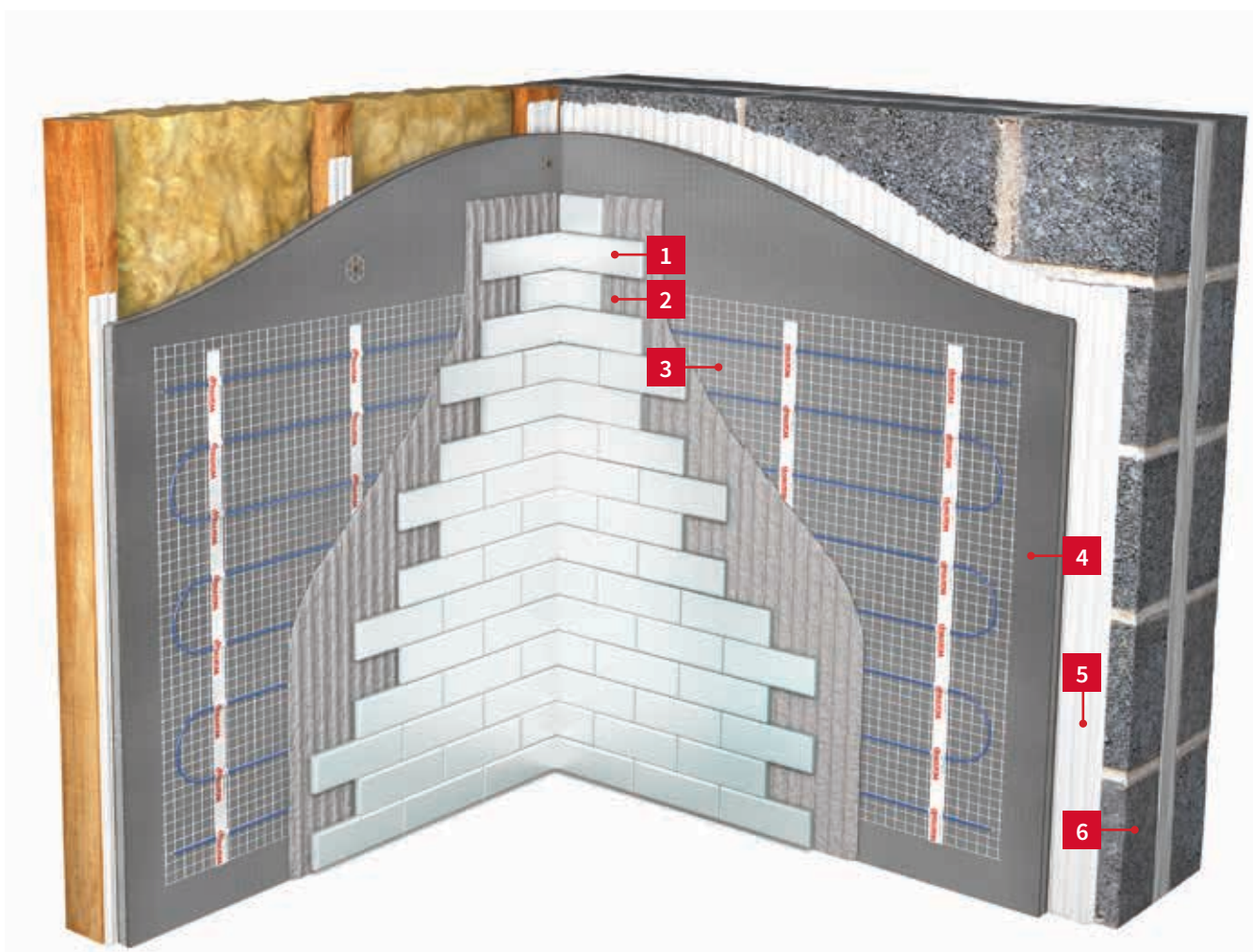

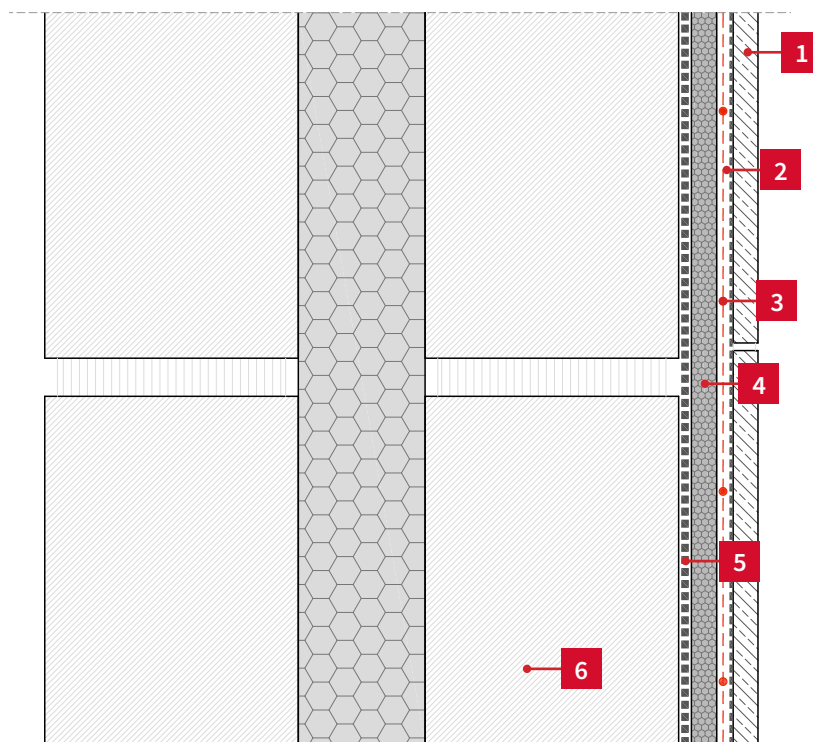

System Description

The walls are lined with Warmups cement faced insulation board before rolling out and bonding the sticky mat to them, being cut and turned to evenly cover the entire area.

The cable positions are documented to allow future fixings to be made with confidence.

The tiles are then mounted over the StickyMat™ and insulated wall as usual.

Features

With both the walls and the floor heated within a room, the room is gaining heat from both of these elements and only loses heat through its windows, roof and through ventilation.

With the radiant temperature typically increased by 4°C, the air temperature can be reduced by an equivalent amount, reducing ventilation losses whilst maintaining comfort.

Technical Information

The ultra-thin, 2mm multi strand, dual core heating cable, is double insulated with an advanced fluoropolymer making it exceptionally tough and easy to tile over.

With BEAB component approval, this KEMA and GS approved CE marked heating element meets the highest safety standards for ultimate peace of mind.



CASE STUDY: Beaufort Park, London, UK

Warmups wall heating systems were specified and installed over 10mm insulation board in 350 bathroom suites.

The 1.8mm heater thickness allowed for no additional wall build up after tiles had been installed but still achieve rapid response when required.

Warmup's Warm wall heaters were installed behind tiled walls supporting a towel rail ensuring that sufficient heat is produced to keep hanging towels warm and dry.



View on our website

For complete case studies visit: www.warmup.co.uk/case-studies/

Cement Coated Tough Insulation Boards

Warmup® Insulation Boards are an important element when installing underfloor heating. They provide the foundation to lay the heating system.

The insulation improves the response time and heat retention within the room reducing energy consumption and carbon emissions.

Warmup Insulation Boards are manufactured from water resistant extruded polystyrene, finished on both faces with a thin layer of fibreglass reinforced cement. They are available in a range of thicknesses, from 6mm to 50mm, to individual project requirements.

They are ideal for tile backing applications on both walls and floors, with the internal layer of insulation capable of supporting 30 tonnes per square metre. The 0.5mm thick cement coating provides an excellent surface for tile adhesive, plaster and

smoothing/leveling compounds, with no priming required.

The low thermal conductivity of the insulation enhances the efficiency of underfloor heating systems, even when used over pre insulated sub floors. This is because they reduce the thermal mass of the floor, significantly reducing the amount of heat absorbed by the sub floor. This allows the underfloor heating system to warm the floor and the room up faster and ensures the floor cools down faster after use.

By reducing the amount of time the room takes to warm up and cool down, the room can spend longer at its cooler set back temperature, reducing its heat loss.

The waterproof insulation panels are suitable for bathrooms and showers as well as dry rooms, allowing the same construction to be used throughout.

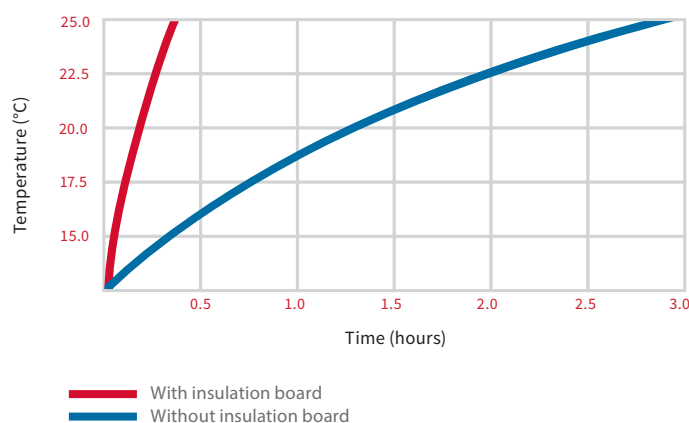

The Warmup Research Centre found that response times were cut from over 2.5 hours to just 20 minutes by including Warmup Coated Insulation within the system installation, placing it between the Warmup Electric Underfloor Heating System and the concrete subfloor.

Notes:

This data applies to Warmup heating products only. Assumes a system running twice a day for 2 hours on a concrete subfloor. Warmup tests performed to EN442-2 standards.





Warmup® Dual Overlay

Warmup® Dual Overlay is a free-floating system designed for use over the Warmup Foil Heating system.

It provides a smooth and seamless subfloor, suitable for soft and resilient floor coverings such as carpet and vinyl.

Warmup Dual overlay is a floating floor system, comprising of two self adhesive layers that bond themselves together to create a smooth floating floor deck over the Foil Heating System.

Installation is quick, clean and dry, making it an easier option for installers as there is no need for leveling compounds. The low thermal resistance, evenly distributes the heat, reducing any hot or cold spots as the heat passes through to the floor finish.

The system consists of a base board and a top board. Both boards are provided with a contact adhesive, bonding them together to make one continuous subfloor, ready for the floor finish to be easily laid over.

The system is available in two formats:

Warmup Dual Overlay (WDO) is an MDF based product. It is designed for use within dry rooms and provides an ideal sub-floor for all resilient floorings such as vinyl, carpet and bonded parquet flooring.

Warmup Dual Overlay Concrete (WDOC) is a cementitious product. It is designed for use within wet or dry rooms and provides an ideal sub-floor tiles as well as the the resilient floorings supported by the WDO version.

FLOOR CONSTRUCTION

- 1 Floor Finish
- 2 Warmup Dual Overlay
- 3 Warmup Foil Heater
- 4 Warmup Insulated Underlay
- 5 Sub-Floor

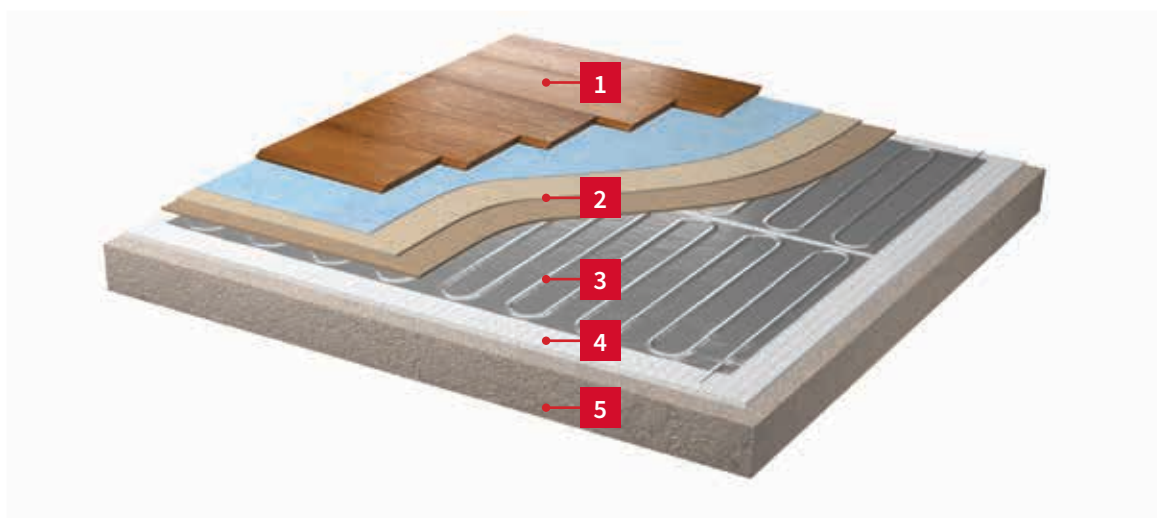

Warmup[®] Outdoor Heating





Winter snow and ice can be dangerous, causing slips, trips and falls, with penetrating ice damaging pavements, roofs and guttering leaving permanent hazards that need to be repaired.

Warmup Outdoor Heating systems allow people to remove both snow and ice from the key areas of risk to themselves on their property whilst significantly improving accessibility in a cost effective way.

Warmup® Snow Melting Cables

The Warmup® Snow Melting Cables protect against snow and ice build-up over both concrete and asphalt surfaces to improve accessibility and avoid accidents.

The 25W/m cables provide enhanced protection against snow and ice, maintaining safe access for vehicles and pedestrians.

Each year thousands of people are admitted to hospital with injuries sustained following a snow or ice related fall with many more people suffering minor injuries that aren't recorded.

With a Warmup system installed and running, safe access can be maintained during spells of snow and ice wherever it is required.

When the system detects snow fall or ice forming it automatically activates, to prevent their build up and deactivates again once it has been cleared to minimise energy usage.

Systems can be designed to provide protection at temperatures down to -20°C by spacing the cables closer together during installation.

FLOOR CONSTRUCTION

- 1 Paving Blocks/Slabs
- 2 Top Bedding Layer
- 3 Warmup Snow Melt Cable
- 4 Warmup Inscreed Rail
- 5 Bottom Bedding Layer
- 6 Sub-Base

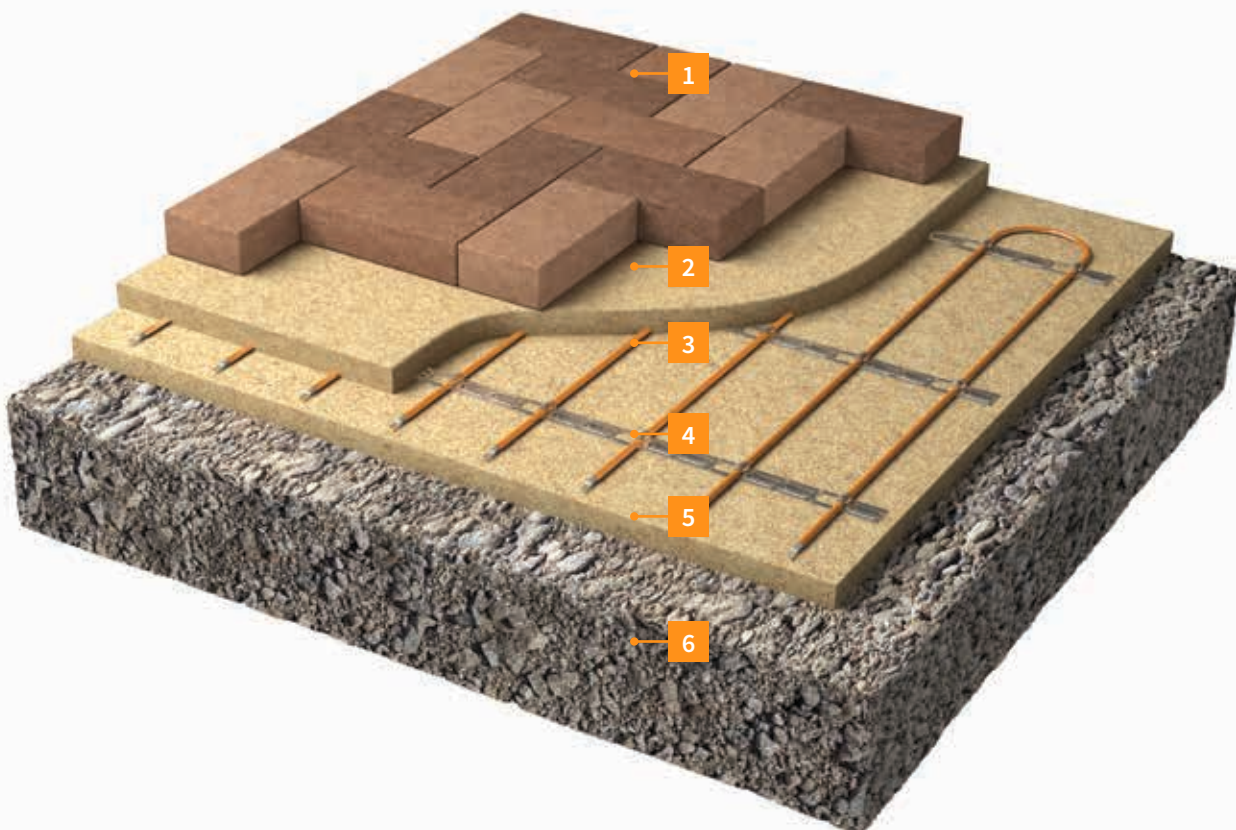

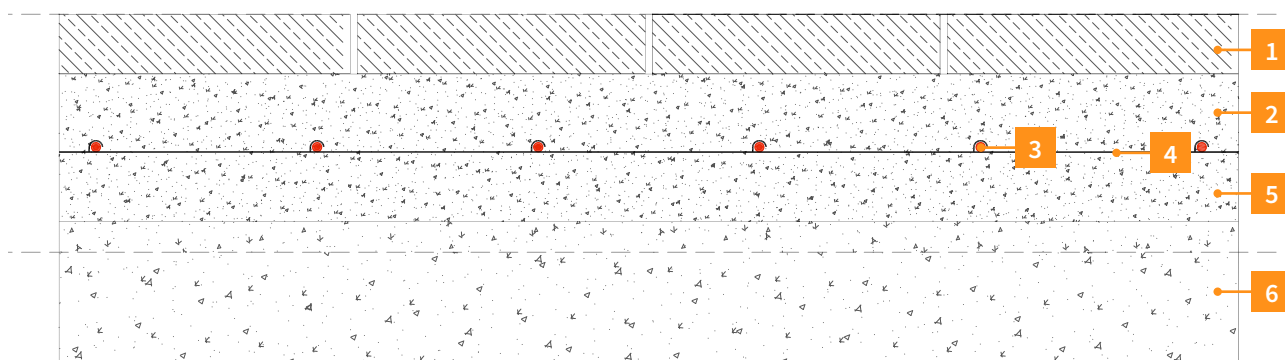

System Description

The supporting layer should be free from sharp objects and edges before placing the cable.

The cables are fixed in to position within the sand, cement or asphalt, using either a reinforcing mesh and zip ties or the Warmup Metal Fixing bands.

The snow sensor is fitted within the active area of the system to enable accurate control.

Features

The Warmup Snow Melt range includes two cable types to keep both concrete and asphalt pavements free of snow and ice.

The asphalt cable can resist temperatures up to 240°C for a short time, safely above the typical 150°C temperature at which the asphalt is laid.

Technical Information

The 230V AC cables provide a fixed heat output of 25W/m and can be laid at spacing's as close as 80mm to provide a system with a capacity of 300W/m² that would typically provide protection down to -20°C

The cables use an advanced fluoropolymer inner insulation and a durable polyolefin outer insulation to provide both temperature and UV resistance.



CASE STUDY: Private Residence in Ulverscroft, Leicestershire, UK

Private Residence in Ulverscroft, Leicestershire.

Warmup's snow melt system was installed throughout numerous external areas on this large private residential property in Leicestershire. The system comprised of over 230m² of snow melt coverage throughout driveways and external hard landscaped areas.



View on our website

Warmup® Self Regulating Cable

Frost Protection and Trace Heating

The Warmup® Self Regulating Cable protects against dangerous build-up of snow and ice on roofs, within gutters and downpipes and prevents pipes from freezing.

The oval 10mm by 6mm self-regulating cable is insulated with a UV stable thermoplastic elastomer, ensuring its durable and simple to fit.

During the winter months when the temperature drops and snow fall increases, roofs, gutters and downpipes are affected.

Gutters and downpipes are filled with snow and ice. Icicles are created as ice cold water trickles over the edge of the gutter.

Should the gutters break and fall under the weight of the snow and ice, or icicles fall as they thaw, there is a risk of serious injury.

The Warmup Self-Regulating Cable de-ices roofs and gutters, removing snow build up and the associated risks whilst creating a clear drainage path for the water created as the rest of the snow and ice melts.

The cables adaptive heat output provides an energy efficient solution, increasing its heat output when needed and saving energy when it is not.

ROOF CONSTRUCTION

- 1 Warmup Roof Fixing Clip
- 2 Warmup Self Regulating Cable
- 3 Roof
- 4 Warmup Gutter Bar
- 5 Gutter
- 6 Drainpipe



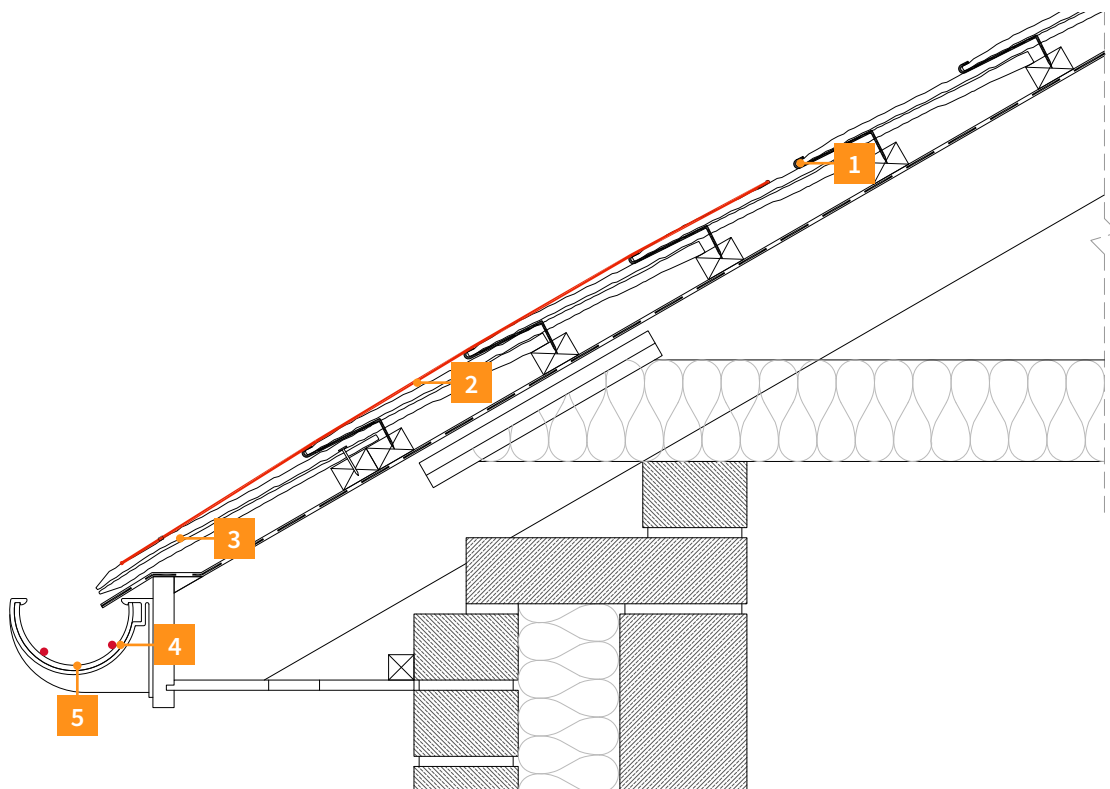

System Description

Cable brackets are fixed to the roof and along the gutters in regular intervals.

The Warmup Self-Regulating Cable is attached to the brackets forming a zig-zag pattern along the roof edge and providing a pair of parallel cables along the gutters and down drainpipes.

The cable is then terminated at the control centre to complete the installation.

Features

Warmup Self-Regulating cable can also be used to provide trace heating.

When the weather is cold enough, insulation alone is not enough to prevent water pipes from freezing or boilers from shutting down as their condensate pipes freeze.

Fitting trace heating underneath the insulation is a simple and effective solution.

Technical Information

The self-regulating cable can be cut to length without affecting its performance, making it easy to install the exact length of cable required.

The thermoplastic elastomer coating on the cable is UV-resistant preventing premature aging due to exposure and ensuring it performs as designed for many years.



CASE STUDY: Tenaris Company, Campina, Romania

The Tenaris Company selected Warmup to install their Self-Regulating cable to protect its gutters and downpipes from ice, snow and the damage.

The system prevents the gutters and downpipes from freezing and becoming blocked, resulting in the inevitable flooding that would occur when it begins to thaw.



View on our website

Support

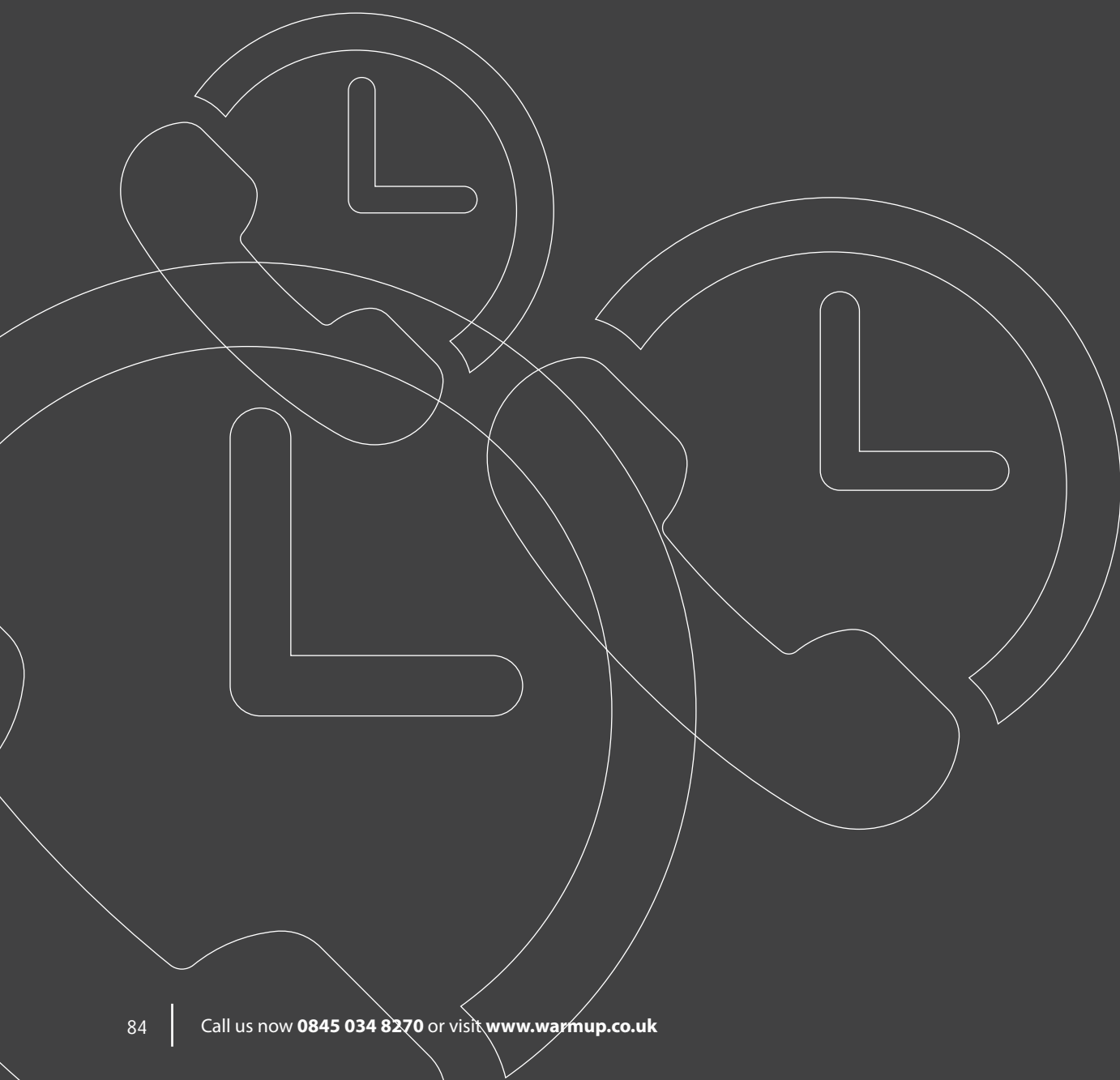



“The Best Floor Heating – Guaranteed”

To the exceptional team that built Warmup, these are not just any words that can be said by any company.

They are our promise – to you.

The warranties on our products are possible thanks to our commitment to Research and Development, on-going quality assurance from the ISO 9001 process and the testing requirements of the BEAB and other regulatory houses.

Projects Department: A Dedicated Service

Warmup offers a dedicated team of Project Directors and Project Managers to help you throughout each stage of your project.

They are allocated to you and your project to support and guide you through the whole process, from specifying to commissioning.

Our Approach

Upon making contact with us to discuss a project, you will be assigned a dedicated Warmup Project Manager who will work with you to define the best solution for your project.

Working from your plans, specifications and ideals, they will propose how to incorporate our floor systems within your planned construction, producing a quotation and specification for you within the next working day.

Depending on the size and scope of your project, you may well be assigned a Project Director. They will work closely with you to highlight ways in which they believe the projects specification could be adjusted to better suit UFH and tailor our service for you, with the aim of reducing your overall costs and increasing our systems efficiency.

Complex projects will take longer to fully specify and where appropriate we will provide advice, guidance and support, both on and off-site, to highlight and avoid potential risks.

We aim to provide the highest quality of products and services, tailored to meet your specific requirements whilst adhering to best industry practices to deliver our service at the right price and at the right time.

Design Process

Warmup products and solutions adhere to industry standards, government legislation and Building Regulations.

The project team, led by your dedicated Project Manager, will always recommend the best underfloor heating solution for your project, mindful of the need to keep to your specification, time schedule and budget.

Our products can be included from the RIBA Stage C – Concept Design. It is at this stage that the Warmup project design team incorporates the development of the general layout, the external envelope and the principals from the project brief. Outline costs and specifications can be provided at this stage for project budgets.

As the project develops into Stage D, the Detailed Design, Warmup products, technical and specific design details can be incorporated. Working in collaboration with you, we will ensure coordination with detailed layouts and any integrated interior designs, providing our own detailed layouts to ensure precise installation and correct zone control.



Warmup provides quality products and services and will:

- ✓ Only promise what we can deliver.
- ✓ Deliver on what we promise.
- ✓ Always remember that the products and services offered and installed by Warmup stand for quality.

We are committed to providing an excellent level of service and aim to deliver this by:

- ✓ Focusing on your needs when recommending solutions, planning and delivering services.
- ✓ Applying the same standard of customer care to all our customers, whilst recognising that customers have individual needs.

The following standards indicate the minimum level of service customers can expect when dealing with Warmup:

- ✓ Requests for quotations will be sent an automatic response acknowledging your request.
- ✓ We will give you the name of the dedicated Project Manager who has been assigned your enquiry and we will give you an indication of when you can expect to receive a response.
- ✓ Should you request us to contact you via telephone, we will agree with you the best time to do so.

With every Warmup quotation We will include a detailed summary of the project in which we will break down:

- ✓ The total gross and heated areas.
- ✓ The total heat load and amperage required.
- ✓ A detailed list of the items required, with relevant technical data supported by illustrations of every item specified, including the controls and details of the supporting Guarantees and Warranties.

Technical Support

All of our systems come complete with installation plans, installation manuals and commissioning guidance.

In addition we have a suite of online tutorial videos but we appreciate that sometimes things just don't go according to plan and we ensure we are there to help during those moments as well.

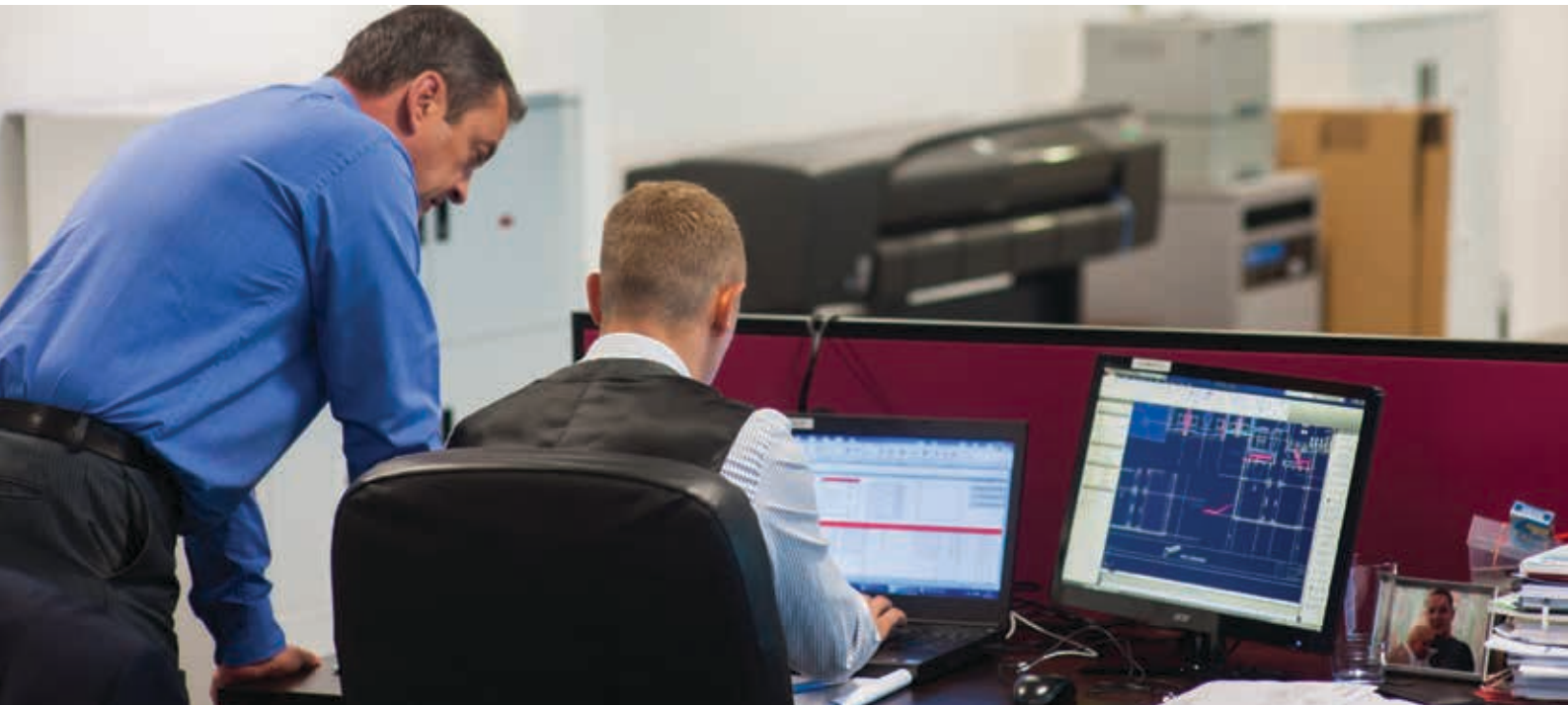

- ✓ We offer support at every stage of a project, from an initial enquiry right through to post completion occupancy and then for the lifetime of the system
- ✓ Support is available from a member of the Warmup team 24 hours a day 365 days a year by calling 0345 345 2288
- ✓ Alternatively we offer online 'live chat' via our website between 08.30 and 17.30 hrs Monday to Friday.
- ✓ If the heating system suffers accidental damage during installation, we will replace it free of charge under our SafetyNet™ Installation Guarantee

SAFETY Net™
Installation-Guarantee

- ✓ If a floor is damaged post installation, we offer a dedicated team of service engineers to identify and rectify the fault

Warranty Durations

Thermostats and Controls

All Warmup thermostats, controllers and wiring centres are warrantied for a period of 3 years.

A Lifetime Warranty upgrade is available on the 4iE, 3iE and Tempo™ thermostats.



Hydronic Systems

Warmup PEX-A Underfloor heating pipe – Lifetime Warranty

Warmup PE-RT Underfloor heating pipe – 50 year Warranty

Warmup PE-RT-Al-PE-RT Underfloor heating – 50 year Warranty

Warmup Manifold – 10 year Warranty

Warmup Actuators – 2 year Warranty

Warmup Pumps – 2 year Warranty Control Systems

Fitting trace heating underneath the insulation is a simple and effective solution.



Electric Systems

Warmup Loose Wire system – Lifetime Warranty

Warmup® StickyMat™ system – Lifetime Warranty

Warmup Inscreed Heating Cable – 10 year Warranty

Warmup Foil Heater – 15 year Warranty



Outdoor Heating

Snow Melting Cable – 10 year Warranty

Self Regulating Cable – 5 year Warranty



Insulation

All Warmup insulation panels are warrantied for a period of 5 years



Index

Welcome

About Our Systems and Services	20
Why Underfloor Heating?	22
The cost of not using Underfloor Heating	29
Research and Development	30

Warmup® Controls

4iE® Smart WiFi Thermostat	34
3iE® Energy-Monitor Thermostat	36
Tempo™ Digital Thermostat	37
ZiE™ Wholehouse Multiple Zone / Heating type System	38
MyHeating™™ App & Web Portal	40

Warmup® Hydronic Systems

Total-16™	44
Forte™	46
Clypso™	48
Metro™	50
Nexxa™	52
Contura™	54
Silva™	56
Tectora™	58
Econna™	60
Manifold	62
Pipe	63
Insulation	63

Warmup® Electric Systems

Inscribed cable	66
Loose Wire System	68
StickyMat™	70
Foil Heater	72
Wall Heating	74
Cement Coated Tough Insulation Boards	76

Warmup® Outdoor Heating

Snow Melt	80
Self Regulating Cable	82

Warmup Support

Projects Department: A Dedicated Service	86
Technical Support	88
Warranty Durations	89

Warmup[®]

The world's **best-selling** floor heating brand™

Warmup Plc
702 & 704 Tudor Estate
Abbey Road
London, NW10 7UW

Tel. 0345 034 8270
Fax. 0345 345 2299

www.warmup.co.uk
projects@warmup.com